

Document Title: <b>Description, complete machine</b>	Function Group: <b>000</b>	Information Type: <b>Service Information</b>	Date: <b>3/25/2026</b>
Profile: <b>EW180C Volvo</b>			

## Description, complete machine

Showing Selected Profile

Valid for serial numbers			
Model	Production site	Serial number start	Serial number stop
EW180C Volvo			

The machine is a wheeled excavator with a 360 degree slew movement.

The machine is equipped with a computerized monitoring system, vehicle control unit (V-ECU) which in turn works with engine control unit (E-ECU).

The machine is equipped with a Volvo D6E, tier 3 compliant, low-emission diesel engine, which is adapted for this excavator model. The engine is controlled by an engine control unit (E-ECU).

The diesel engine drives the machine's working pump, which gives hydraulic flow to the working hydraulics and the travel motor. Gear pump supplies the servo hydraulics. The fan pump mounted on the engine supplies the hydraulic flow to the cooling fan motor for the radiator, hydraulic oil cooler, charge air cooler and air conditioner condenser. The tandem pump is mounted behind the working pump. The hydraulic system is monitored and controlled by the vehicle control unit (V-ECU).

The machine has a load-sensing hydraulic system which always ensures that each movement receives oil according to the demand.

Propulsion of the machine is obtained with a hydraulic travel motor with variable displacement.

The travel gearbox has two hydraulically controlled gears. It is a so-called Powershift gearbox, which means that shifting is possible on the move. The brakes for gear shifting are applied automatically with spring force and released with servo pressure. The parking brake is applied with spring force, is integrated in the gearbox and uses the gearbox brake discs.

The superstructure is slewed using an axial piston motor with integrated planetary gear. The slew brake is applied automatically by spring force and released with the system pressure.

The slew pinion drives against a slew ring with internal ring gear. The slew ring connects the superstructure with the undercarriage.

A centre passage connects the superstructure and undercarriage hydraulically and electrically.

The cab is equipped with an ergonomic operator's seat, ventilation and filtration system. The cab is also prepared for air conditioning (option).

Different combinations of boom, dipper arm and attachments can be offered. This manual describes the most common standard alternatives.

When ordering spare parts and when making enquiries on the telephone or by correspondence, the model designation and serial number should be given. When applicable, the information marked on individual parts should also be given.

Document Title: <b>Component locations</b>	Function Group: <b>000</b>	Information Type: <b>Service Information</b>	Date: <b>3/25/2026</b>
Profile: <b>EW180C Volvo</b>			

## Component locations

Showing Selected Profile

Valid for serial numbers			
Model	Production site	Serial number start	Serial number stop
EW180C Volvo			

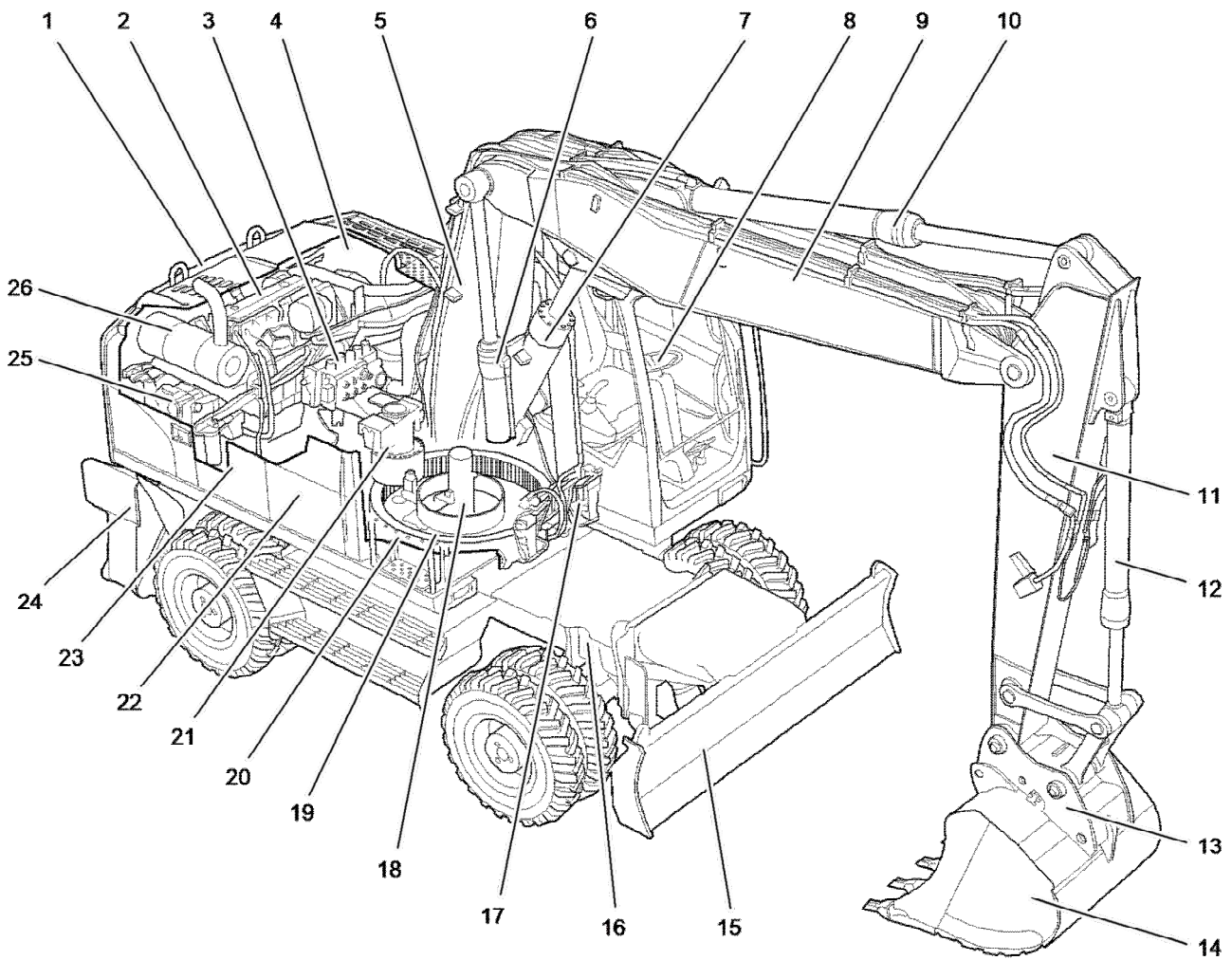

V1048162

**Figure 1**

Main component locations

1	Counterweight	14	Bucket
2	Engine	15	Stabiliser blade
3	Main control valve	16	Pivot axle lock
4	Radiator and oil cooler	17	Boom control valve/line rupture valve

5	First boom	18	Center passage
6	First boom cylinder	19	Slew ring gear
7	Second boom cylinder	20	Batteries
8	Steering wheel	21	Slew unit
9	Second boom	22	Fuel tank
10	Dipper arm cylinder	23	Hydraulic oil tank
11	Dipper arm	24	Stabiliser
12	Bucket cylinder	25	Hydraulic pump
13	Quickfit	26	Muffler

Document Title: <b>Product plates</b>	Function Group: <b>000</b>	Information Type: <b>Service Information</b>	Date: <b>3/25/2026</b>
Profile: <b>EW180C Volvo</b>			

## Product plates

Showing Selected Profile

Valid for serial numbers			
Model	Production site	Serial number start	Serial number stop
EW180C Volvo			

When ordering spare parts, and in all telephone enquiries or correspondence the model designation and the Product Identification Number (PIN) must always be quoted.

### Product plate

The product plate on the machine shows the manufacturer's name and address, model designation, PIN, machine weight, engine output, production year and year of delivery. There is also room for the CE mark. The plate is positioned under the boom on the superstructure frame.

### Engine product plate

The engine product plate contains type designation and part and serial numbers and is positioned on the engine inside the rear engine cover on the right side of the machine.

### Travel gearbox product plate

The gearbox product plate contains type designation and part and serial numbers and is positioned on the travel gearbox.

### Axle product plate

The axle product plate contains type designation and part and serial numbers and is positioned on each axle.

Document Title: <b>Tightening torques</b>	Function Group: <b>030</b>	Information Type: <b>Service Information</b>	Date: <b>3/25/2026</b>
Profile: <b>EW180C Volvo</b>			

## Tightening torques

Showing Selected Profile

Valid for serial numbers			
Model	Production site	Serial number start	Serial number stop
EW180C Volvo			

### Wheel nuts

Wheel nuts		
		
Thread M	Wrench size (width across flats)	Tightening torque (Nm)
M22 x 1.5	30	560 – 600

### Hydraulic connections, general

Before fitting pipe couplings, plugs and hoses:

- Make sure that the sealing surfaces are clean and free from pores or scratches.
- Check elastic seal rings for defects.
- Oil in threads, sealing surfaces and contact surfaces except for ORFS-connections (ORFS = O-Ring Face Seal).

### Valve connections

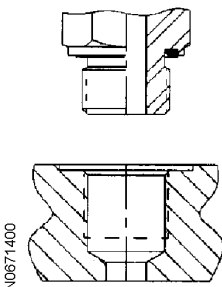
Valve connections, ORFS-connections with ED seals (DIN 3852 form E)		
		
Connection thread (mm)	Wrench size, width across flats (mm)	Tightening torque (Nm)
M10 x 1.0		19
M12 x 1.5	17	37
M14 x 1.5	22	58
M16 x 1.5	22	74
M18 x 1.5	24	94
M20 x 1.5		130
M22 x 1.5	27	140
M27 x 2.0	32	190
M33 x 2.0	41	330

M42 x 2.0	50	470
M48 x 2.0	55	570
<b>Connection thread (inches)</b>	<b>Wrench size, width across flats (mm)</b>	<b>Tightening torque (Nm)</b>
G 1/8	17 alt. 19	19
G 1/4	19 alt. 22	58
G 3/8	22 alt. 27	84
G 1/2	27 alt. 32	120
G 3/4	32 alt. 41	190
G 1	41 alt. 46	330
G 1 1/4	50	470
G 1 1/2	55	570

**Valve connections, ORFS-connections with O-ring seals (ISO 6149)**

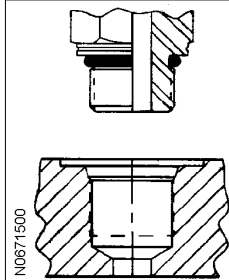

Connection thread (mm)	Wrench size, width across flats (mm)	Tightening torque (Nm)
M8 x 1.0		11
M10 x 1.0		21
M12 x 1.5	17 alt. 19	37
M14 x 1.5	19 alt. 22	47
M16 x 1.5	22	58
M18 x 1.5	24 alt. 27	74
M22 x 1.5	27 alt. 32	110
M27 x 2.0	32	180
M33 x 2.0	32, 41 alt. 46	330
M42 x 2.0	50	350
M48 x 2.0	55	440
<b>Connection thread (inches)</b>	<b>Wrench size, width across flats (mm)</b>	<b>Tightening torque (Nm)</b>
7/16 – 20 UNF	16	21
1/2 – 20 UNF		26
9/16 – 18 UNF	19	37
3/4 – 16 UNF	22	74
7/8 – 14 UNF	27	110
1 1/16 – 12 UNF	41	180
1 5/16 – 12 UNF	41	284
1 5/8 – 12 UNF	50	300
1 7/8 – 12 UNF	55	390

**Blanking plugs**

**Blanking plugs with ED seal**

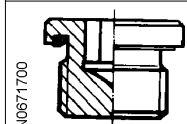

Connection thread (mm)	Allen key dim. (mm)	Tightening torque (Nm)
M10 x 1.0	5	12
M12 x 1.5	6	25
M14 x 1.5	6	35
M16 x 1.5	8	55
M18 x 1.5	8	65
M20 x 1.5	10	80
M22 x 1.5	10	90
M26 x 1.5	12	100
M27 x 2.0	12	140
M33 x 2.0	17	230
M42 x 2.0	22	360
M48 x 2.0	24	360
Connection thread (inches)	Allen key dim. (mm)	Tightening torque (Nm)
G 1/8	5	13
G 1/4	6	30
G 3/8	8	60
G 1/2	10	80
G 3/4	12	140
G 1	17	200
G 1 1/4	22	400
G 1 1/2	24	450

**Blanking plugs with O-ring seal (ISO 6149)**

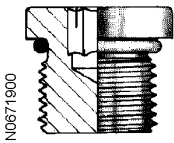

Connection thread (mm)	Allen key dim. (mm)	Tightening torque (Nm)
M10 x 1.0	5	20
M12 x 1.5	6	35
M14 x 1.5	6	45
M16 x 1.5	8	55
M18 x 1.5	8	70
M20 x 1.5	10	80
M22 x 1.5	10	100
M26 x 1.5	12	130
M27 x 2.0	12	170
M33 x 2.0	14	310
M42 x 2;0	22	330

**ORFS-connections**

**ORFS-connections (ISO 8434-3)**

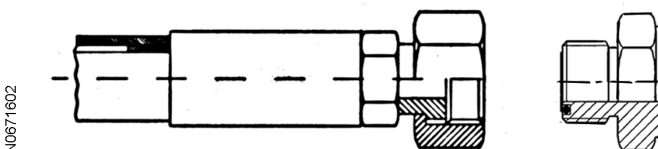

Thread (inches)	Wrench size, width across flats (mm)	Tightening torque (Nm) *
-----------------	--------------------------------------	--------------------------

9/16 – 18 UNF	17 alt. 19	25
11/16 – 16 UN	22	35
13/16 – 16 UN	24	55
1 – 14 UNS	30	85
1 3/16 – 12 UN	36	120
1 7/16 – 12 UN	41 alt. 46	160
1 11/16 – 12 UN	50	200
2 – 12 UN	60	260

\* Threads and sealing surface must not be oiled in before tightening.

### Hose clamps

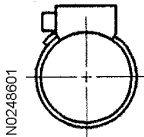
Hose clamps with worms		
		
Intended for hose outside diameter (mm)	Wrench size, width across flats (mm)	Tightening torque (Nm)
10 – 19	7	2.5
20 – 30	7	3.5
31 – 49	7	4.5
50 – 231	7	5.5

### Bolts and nuts

The pretensioning force achieved at a given tightening torque depends on the coefficient of friction of the bolted joint. The coefficient of friction in turn depends on the surface texture, surface treatment and lubricated condition. The values are calculated assuming a coefficient of friction of 0.2 for a dry chromated flange bolt and 0.15 for a lubricated chromated flange bolt. The lower torque for Allen bolts and traditional hex bolts, in relation to flange bolts, is due to the shorter torque arm for the frictional force under the bolt head (smaller diameter of bolt head).

The following abbreviations for surface treatment are used in the tables:

- Fe/Zn-Fe = Black chromated zinc - iron
- FZB = Blank chromated

#### NOTE!

In some body parts, there are weld bolts with much lower strength than normal bolts of the same dimension.

#### NOTE!

When Nordloc washer is used, increase the torque by 20%.

#### NOTE!

Bolts provided with liquid alt. micro-capsuled thread locker or thread sealant shall be tightened with the same torque as a lubricated bolt of the same type.

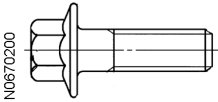
Flange bolts						
						Blind rivet nut
Thread (mm)	Wrench size, width across flats (mm)	Torque (Nm)				Torque (Nm)
		8.8 Fe/Zn-Fe Dry	8.8 Fe/Zn-Fe Lubricated	10.9 Phosphated	10.9 Phosphated Lubricated	Dry

M5	8	7	6			6
M6	10	12	10			10
M8	12	28	24			24
M10	14	56	48	70	60	48
M12	17	100	85	125	105	82
M14	18	160	140	200	175	
M16	21	250	220	320	275	

Hex bolts and Allen head bolts								Blind rivet nut
Wrench size (width across flats)		Torque (Nm)					Torque (Nm)	
Thread (mm/inch)	Hex bolt (mm/inch)	Allen head bolt (mm/inch)	8.8 FZB & Fe/Zn-Fe Dry	8.8 FZB & Fe/Zn-Fe Lubricated	10.9 Phosphated Lubricated	12.9 Untreated Lubricated	Dry	
M5	8	4	6	5			6	
M6	10	5	10	9		20	10	
M8	13	6	25	22		40	24	
M10	16	8	50	44	60	80	48	
M12	18	10	90	75	105	140	82	
M14	21	12	140	125	175	220		
M16	24	14	220	190	275	340		
M20	30	17	450	380	540	650		
M24	36	19	770	660	900	1 120		
M27	41	–	1 100	940	1 350	1 620		
M30	46	22	1 500	1 280	1 840	2 210		
M36	55		2 500	2 300	3 210	3 850		
1/4 UNC	7/16	3/16	12	10	15	20		
5/16 UNC	1/2	1/4	25	21	30	40		
3/8 UNC	9/16	5/16	45	38	55	70		
7/16 UNC	5/8		65	55	90			
1/2 UNC	3/4	3/8	100	85	130	170		
9/16 UNC	13/16		145	123	190			

Nuts on weld bolts (material S235JRG2-EN 10025)	
Thread	Torque (Nm)
M6	5
M8	12

**Tolerances**

Modern high-quality torque wrenches normally give a variation of ± 5 % of the indicated value. This, together with variations in friction coefficient, gives a range in the pretensioning force of approximately ± 16 % for lubricated bolted joints and ± 29

% for dry bolted joints.

Document Title: <b>Conversion tables</b>	Function Group: <b>030</b>	Information Type: <b>Service Information</b>	Date: <b>3/25/2026</b>
Profile: <b>EW180C Volvo</b>			

## Conversion tables

Showing Selected Profile

Valid for serial numbers			
Model	Production site	Serial number start	Serial number stop
EW180C Volvo			

### Length

Unit	cm	m	km	in	ft	yd	mile
cm	1	0.01	0.00001	0.3937	0.03281	0.01094	0.000006
m	100	1	0.001	39.37	3.2808	1.0936	0.00062
km	100000	1000	1	39370.7	3280.8	1093.6	0.62137
in	2.54	0.0254	0.000025	1	0.08333	0.02777	0.000015
ft	30.48	0.3048	0.000304	12	1	0.3333	0.000189
yd	91.44	0.9144	0.000914	36	3	1	0.000568
mile	160930	1609.3	1.6093	63360	5280	1760	1

1 mm = 0.1 cm - 1 mm = 0.001 m

### Area

Unit	cm <sup>2</sup>	m <sup>2</sup>	km <sup>2</sup>	a	ft <sup>2</sup>	yd <sup>2</sup>	in <sup>2</sup>
cm <sup>2</sup>	1	0.0001	-	0.000001	0.001076	0.000012	0.155000
m <sup>2</sup>	10000	1	0.000001	0.01	10.764	1.1958	1550.000
km <sup>2</sup>	-	1000000	1	10000	1076400	1195800	-
a	0.01	100	0.0001	1	1076.4	119.58	-
ft <sup>2</sup>	-	0.092903	-	0.000929	1	0.1111	144.000
yd <sup>2</sup>	-	0.83613	-	0.008361	9	1	1296.00
in <sup>2</sup>	6.4516	0.000645	-	-	0.006943	0.000771	1

1 ha = 100 a - 1 mile<sup>2</sup> = 259 ha = 2.59 km<sup>2</sup>

### Volume

Unit	cm <sup>3</sup> = cc	m <sup>3</sup>	l	in <sup>3</sup>	ft <sup>3</sup>	yd <sup>3</sup>
cm <sup>3</sup> = ml	1	0.000001	0.001	0.061024	0.000035	0.000001
m <sup>3</sup>	1000000	1	1000	61024	35.315	1.30796
dm <sup>3</sup> (l)	1000	0.001	1	61.024	0.035315	0.001308
in <sup>3</sup>	16.387	0.000016	0.01638	1	0.000578	0.000021
ft <sup>3</sup>	28316.8	0.028317	28.317	1728	1	0.03704
yd <sup>3</sup>	764529.8	0.76453	764.53	46656	27	1

1 gal (US) = 3785.41 cm<sup>3</sup> = 231 in<sup>3</sup> = 0.83267 gal (UK)

### Weight

Unit	g	kg	t	oz	lb
g	1	0.001	0.000001	0.03527	0.0022
kg	1000	1	0.001	35.273	2.20459
t	1000000	1000	1	35273	2204.59
oz	28.3495	0.02835	0.000028	1	0.0625
lb	453.592	0.45359	0.000454	16	1

1 ton (metric) = 1.1023 ton (US) = 0.9842 ton (UK)

### Pressure

Unit	kp/cm <sup>2</sup>	bar	Pa=N/m <sup>2</sup>	kPa	lbf/in <sup>2</sup>	lbf/ft <sup>2</sup>
kp/cm <sup>2</sup>	1	0.98067	98066.5	98.0665	14.2233	2048.16
bar	1.01972	1	100000	100	14.5037	2088.6
Pa=N/m <sup>2</sup>	0.00001	0.001	1	0.001	0.00015	0.02086
kPa	0.01020	0.01	1000	1	0.14504	20.886
lbf/in <sup>2</sup>	0.07032	0.0689	6894.76	6.89476	1	144
lbf/ft <sup>2</sup>	0.00047	0.00047	47.88028	0.04788	0.00694	1

kg/cm<sup>2</sup> = 735.56 Dry (mmHg) = 0.96784 atm

### Unit explanations

Unit	abbreviation
Newton meter	Nm
Kilopoundmeter	kpm
Kilopascal	kPa
Megapascal	MPa
Kilowatt	kW
kilojoule	kJ
British thermal unit	Btu
Calorie	ca

### Approx. conversion

SI unit	Conversion factor	Non SI	Conversion factor	SI
<b>Torque</b>				
Nm	x10.2	=kg/cm	x0.8664	=lb in
Nm	x0.74	=lbf-ft	x1.36	=Nm
Nm	x0.102	=kg/m	x7.22	=lbft
<b>Pressure (Pa = N/m<sup>2</sup>)</b>				
kPa	x4.0	=in.H <sub>2</sub> O	x0.249	=kPa
kPa	x0.30	=in.Hg	x3.38	=kPa
kPa	x0.145	=psi	x6.89	=kPa
bar	x14.5	=psi	x0.069	=bar
kp/cm <sup>2</sup>	x14.22	=psi	x0.070	=kp/cm <sup>2</sup>
N/mm <sup>2</sup>	x145.04	=psi	x0.069	=bar
MPa	x145	=psi	x0.00689	=MPa
<b>Power (W = J/s)</b>				
kW	x1.36	=hp(cv)	x0.736	=kW

kW	x1.34	= bhp	x0.746	= kW
kW	x0.948	= Btu/s	x1.055	= kW
W	x0.74	= ft-lb/s	x1.36	= W
Energy (J = Nm)				
kJ	x0.948	= Btu	x1.055	= kJ
J	x0.239	= calorie	x4.19	= J
Speed and acceleration				
m/s <sup>2</sup>	x3.28	= ft/s <sup>2</sup>	x0.305	= m/s <sup>2</sup>
m/s	x3.28	= ft/s	x0.305	= m/s
km/h	x0.62	= mph	x1.61	= km/h
Horsepower/torque				
Bhp x5252 rpm = TQ (lb-ft)			TQ x rpm 5252 = bhp	
Temperature				
$^{\circ}\text{C} = (^{\circ}\text{F} - 32) / 1.8$			$^{\circ}\text{F} = (^{\circ}\text{C} \times 1.8) + 32$	
Flow factor				
l/min (dm <sup>3</sup> /min)	x0.264	= US gal/min	x3.785	= liter/min

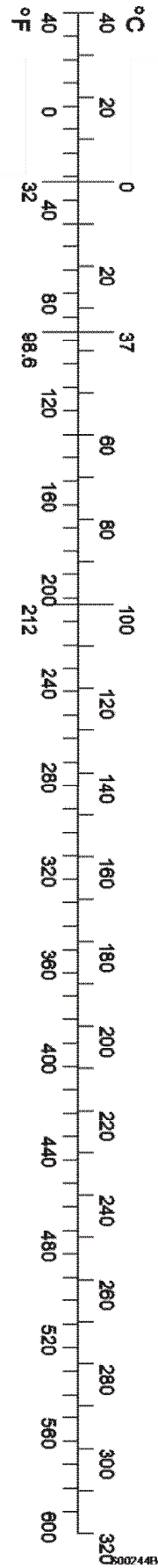

Figure 1

Document Title: <b>Engine, specifications</b>	Function Group: <b>030</b>	Information Type: <b>Service Information</b>	Date: <b>3/25/2026</b>
Profile: <b>EW180C Volvo</b>			

[Go back to Index Page](#)

## Engine, specifications

Showing Selected Profile

Valid for serial numbers			
Model	Production site	Serial number start	Serial number stop
EW180C Volvo	Konz	120010	122499

Model	Used in	Output	Engine speed (rpm)
D6E ECE3	EW180C	122 kW	1900 rpm

Items	Specifications
Type	Four-stroke diesel Turbocharged Water cooled
Fuel injection type	Deutz common rail system
Number of cylinders	6, vertical in line
Number of valves	12
Displacement	5.7 dm <sup>3</sup> (1.5 US gal)
Bore x stroke	98 mm x 126 mm (3.86 in x 4.96 in)
Rotational direction	Facing flywheel, counter-clockwise
Compression ratio	18:1
Compression pressure	30 – 38 bar (3.0 – 3.8 MPa)
Injection order	1-5-3-6-2-4
Maximum torque	730 Nm at 1400 rpm
Low idle rpm	800 rpm
High idle rpm	1850 rpm
Tier 3 emission certifications	US EPA40 CFR: part 9.86 and 89 CARB EU 97/68/EC ECE R24-3

Document Title: <b>Engine, specifications</b>	Function Group: <b>030</b>	Information Type: <b>Service Information</b>	Date: <b>3/25/2026</b>
Profile: <b>EW180C Volvo</b>			

[Go back to Index Page](#)

## Engine, specifications

Showing Selected Profile

Valid for serial numbers			
Model	Production site	Serial number start	Serial number stop
EW180C Volvo	Konz	122501	999999

Model	Used in	Output	Engine speed (rpm)
D6E	EW180C	122 kW	1900 rpm

Items	Specifications
Type	Four-stroke diesel Turbocharged Water cooled
Fuel injection type	Deutz common rail system
Number of cylinders	6, vertical in line
Number of valves	12
Displacement	5.7 dm <sup>3</sup> (1.5 US gal)
Bore x stroke	98 mm x 126 mm (3.86 in x 4.96 in)
Rotational direction	Facing flywheel, counter-clockwise
Compression ratio	18:1
Compression pressure	30 – 38 bar (3.0 – 3.8 MPa)
Injection order	1-5-3-6-2-4
Maximum torque	730 Nm at 1400 rpm
Low idle rpm	800 rpm
High idle rpm	1850 rpm

Document Title: <b>Engine, weight</b>	Function Group: <b>030</b>	Information Type: <b>Service Information</b>	Date: <b>3/25/2026</b>
Profile: <b>EW180C Volvo</b>			

## Engine, weights

Showing Selected Profile

<b>Valid for serial numbers</b>			
<b>Model</b>	<b>Production site</b>	<b>Serial number start</b>	<b>Serial number stop</b>
EW180C Volvo			

Engine, dry, approx.	530 kg (1168.4 lbs)
----------------------	---------------------

Document Title: <b>Valve clearance, specifications</b>	Function Group: <b>030</b>	Information Type: <b>Service Information</b>	Date: <b>3/25/2026</b>
Profile: <b>EW180C Volvo</b>			

## Valve system specifications

Showing Selected Profile

Valid for serial numbers			
Model	Production site	Serial number start	Serial number stop
EW180C Volvo			

Valves	
Valve head diameter:	
inlet	44.4 ±0.1 mm (1.75 ±0.004 in)
exhaust	38.7 ±0.1 mm (1.52 ±0.004 in)
Valve stem, diameter:	
inlet	7.94 – 0.04 mm (0.31 –0.0015 in)
exhaust	7.94 – 0.04 mm (0.31 –0.0015 in)
Valve clearance, cold engine, value when adjusting:	
inlet	To zero clearance, then 75° counter-clockwise
exhaust	To zero clearance, then 120° counter-clockwise
Clearance between control valve piston and rocker arm	To zero clearance, then 144° counter-clockwise
Measurement between valve disc and cylinder head's face:	
inlet	0.9 +0.15 –0.1 mm (0.035 +0.006 –0.0039 in)
exhaust	0.9 +0.15 –0.1 mm (0.035 +0.006 –0.0039 in)
Valve head edge, thickness:	
inlet	2.36 mm (0.09 in)
exhaust	1.8 mm (0.07 in)

Valve guides	
Max. clearance valve stem - guide, wear tolerance:	
Inlet	0.07 — 0.13 mm (0.0027 — 0.0052 in)
Outlet	0.07 — 0.13 mm (0.0027 — 0.0052 in)

Valve springs	
Inlet/exhaust	
Length, unloaded	59 ±1.9 mm (2.32 ±0,039 in)
Diameter, thread	4 ±0.03 mm (0.157 ±0,012 in)

Rocker arm	
Hole diameter inlet, exhaust	21.02 +0.033 (0.828 +0.0013 in)
Tapp	21 –0.021 (0.827 –0.0008 in)

Valve seat	
Valve seat diameter:	

Inlet	46.09 -0.02 mm
Outlet	39.99 -0.02 mm
Valve seat angle:	
Inlet	30°
Outlet	45°

Document Title: <b>Flywheel, weight</b>	Function Group: <b>030</b>	Information Type: <b>Service Information</b>	Date: <b>3/25/2026</b>
Profile: <b>EW180C Volvo</b>			

## Flywheel, weight

Showing Selected Profile

<b>Valid for serial numbers</b>			
<b>Model</b>	<b>Production site</b>	<b>Serial number start</b>	<b>Serial number stop</b>
EW180C Volvo			

Flywheel, approx.	55 kg (112 lbs)
-------------------	-----------------

Document Title: <b>Lubrication specifications</b>	Function Group: <b>system, 030</b>	Information Type: <b>Service Information</b>	Date: <b>3/25/2026</b>
Profile: <b>EW180C Volvo</b>			

## Lubrication system, specifications

Showing Selected Profile

Valid for serial numbers			
Model	Production site	Serial number start	Serial number stop
EW180C Volvo			

Lubrication system	
Oil pressure maximum warm engine, high idling speed	450–500 kPa (4.5–5 bar) (65–72 psi)
Min. oil pressure, hot engine, low idling speed	60 kPa (0.6 bar) (8.7 psi)

Document Title: <b>Fuel specifications</b>	Function Group: <b>pressure, 030</b>	Information Type: <b>Service Information</b>	Date: <b>3/25/2026</b>
Profile: <b>EW180C Volvo</b>			

## Fuel pressure, specifications

Showing Selected Profile

Valid for serial numbers			
Model	Production site	Serial number start	Serial number stop
EW180C Volvo			

Fuel feed pressure	
Minimum pressure in engine starting condition	0.35 ±0.05 MPa, 51 ±7 psi, 3.5 ±0.5 bar
Minimum pressure in engine running condition	0.6 ±0.05 MPa, 87 ±7 psi, 6.0 ±0.5 bar
Maximum pressure in the pump pressure relive valve	1.15 ±0.15 MPa, 167 ±22 psi, 11.5 ±1.5 bar

Fuel return pressure	
Maximum pressure in engine starting condition	0.03 MPa, 4.4 psi, 0.3 bar
Maximum pressure in engine running condition	0.05 MPa, 7.3 psi, 0.5 bar

Fuel control unit (FCU) pressure	
Pressure in engine starting condition	0.07 ±0.04 MPa, 10 ±6 psi, 0.7 ±0.4bar
Pressure without load in engine running condition	0.1 ±0.01 MPa, 15 ±2 psi, 1 ±0.1 bar
Pressure with load in engine running condition	0.09–0.16 MPa, 13–23 psi, 0.9–1.6 bar
Pressure without regulation in engine running condition	0.45 ±0.02 MPa, 65 ±3 psi, 4.5 ±0.2 bar

High pressure fuel pump output pressure at testing condition	
Output pressure	55 ±5 MPa, 7979 ±725 psi, 550 ±50 bar

Fuel rail pressure	
Pressure in engine starting condition	30 ±5 MPa, 4352 ±725 psi, 300 ±50 bar (at charge air pressure 0 MPa, 0 psi, 0 bar)
Pressure with rail PRV open in running conditions	70 ±5 MPa, 10153 ±725 psi, 700 ±50 bar
Pressure with <b>load above 60%</b> in engine running condition	80–150 MPa, 11606–21762 psi, 800–1500 bar (at charge air pressure 0.05–0.25 MPa, 7.3–36.3 psi, 0.5–2.5 bar)
Pressure with <b>the engine load below 28%</b> in engine running condition	
Engine step 1, 750-800 rpm	40 ±1 MPa, 5803 ±145 psi, 400 ±10 bar (at charge air pressure 0 MPa, 0 psi, 0 bar)
Engine step 2, 890-940 rpm	42.5 ±1 MPa, 6166 ±145 psi, 425 ±10 bar (at charge air pressure 0 MPa, 0 psi, 0 bar)
Engine step 3, 1030-1080 rpm	47 ±1 MPa, 6819 ±145 psi, 470 ±10 bar (at charge air pressure 0 MPa, 0 psi, 0 bar)
Engine step 4, 1160-1210 rpm	54 ±1 MPa, 7834 ±145 psi, 540 ±10 bar (at charge air pressure 0 MPa, 0 psi, 0 bar)
Engine step 5, 1300-1350 rpm	62 ±1 MPa, 8995 ±145 psi, 620 ±10 bar (at charge air pressure 0–0.003 MPa, 0–0.44 psi, 0–0.03 bar)

Engine step 6, 1440-1490 rpm	64.8 ±1 MPa, 9398 ±145 psi, 648 ±10 bar (at charge air pressure 0.001–0.004 MPa, 0.15–0.58 psi, 0.01–0.04 bar)
Engine step 7, 1580-1630 rpm	68 ±1 MPa, 9865 ±145 psi, 680 ±10 bar (at charge air pressure 0.004–0.008 MPa, 0.58–1.16 psi, 0.04–0.08 bar)
Engine step 8, 1710-1760 rpm	70 ±1 MPa, 10155 ±145 psi, 700 ±10 bar (at charge air pressure 0.008–0.013 MPa, 1.16–1.89 psi, 0.08–0.13 bar)
Engine step 9, 1850-1900 rpm	70 ±1 MPa, 10155 ±145 psi, 700 ±10 bar (at charge air pressure 0.01–0.018 MPa, 1.45–2.6 psi, 0.1–0.18 bar)

Document Title: <b>Fuel tank, specifications</b>	Function Group: <b>030</b>	Information Type: <b>Service Information</b>	Date: <b>3/25/2026</b>
Profile: <b>EW180C Volvo</b>			

## Fuel tank, specification

Showing Selected Profile

<b>Valid for serial numbers</b>			
<b>Model</b>	<b>Production site</b>	<b>Serial number start</b>	<b>Serial number stop</b>
EW180C Volvo			

<b>Fuel tank</b>	
Volume	295 liter (77.9 gal)
Weight	156 kg (344 lb)

Document Title: <b>Injectors, specifications</b>	Function Group: <b>030</b>	Information Type: <b>Service Information</b>	Date: <b>3/25/2026</b>
Profile: <b>EW180C Volvo</b>			

## Injectors, specifications

Showing Selected Profile

<b>Valid for serial numbers</b>			
<b>Model</b>	<b>Production site</b>	<b>Serial number start</b>	<b>Serial number stop</b>
EW180C Volvo			

Nozzle type injector	7 holes
Common rail system pressure	30-160 MPa (300-1600 bar, 4352-23212 psi)

Document Title: <b>Cooling specifications</b>	Function Group: <b>system, 030</b>	Information Type: <b>Service Information</b>	Date: <b>3/25/2026</b>
Profile: <b>EW180C Volvo</b>			

## Cooling system, specifications

Showing Selected Profile

Valid for serial numbers			
Model	Production site	Serial number start	Serial number stop
EW180C Volvo			

### Specifications

Item		Unit	Specifications
Radiator	Core size (W × H × D)	mm	800 × 414 × 140
		in	31.5 × 16.3 × 5.5
Hydraulic oil cooler	Core size (W × H × D)	mm	800 × 292 × 140
		inch	31.5 × 11.5 × 5.5
Charge air cooler	Core size (W × H × D)	mm	800 × 163 × 140
		inch	31.5 × 6.4 × 5.5
Complete cooling system weight		kg (lb)	105 (231.5)

Document Title: <b>Coolant pump, thermostat, specifications</b>	Function Group: <b>030</b>	Information Type: <b>Service Information</b>	Date: <b>3/25/2026</b>
Profile: <b>EW180C Volvo</b>			

## Coolant pump, thermostat, specifications

Showing Selected Profile

Valid for serial numbers			
Model	Production site	Serial number start	Serial number stop
EW180C Volvo			

Coolant pump, type	Belt-driven centrifugal pump
Thermostat, type	Piston thermostat
Quantity	1
Coolant thermostat begins to open at	83 °C (181 °F)
Coolant thermostat fully open at	95 °C (203 °F)
Coolant thermostat stroke distance	8 mm (0.32 in)

Document Title: <b>Engine speed control switch, specifications</b>	Function Group: <b>030</b>	Information Type: <b>Service Information</b>	Date: <b>3/25/2026</b>
Profile: <b>EW180C Volvo</b>			

## Engine speed control switch, specifications

Showing Selected Profile

Valid for serial numbers			
Model	Production site	Serial number start	Serial number stop
EW180C Volvo			

Item	Specification
Power supply	DC 24 V
Duty	10 - 90%
Type	PWM signal generator

Document Title: <b>Electrical specifications</b>	Function Group: <b>system, 030</b>	Information Type: <b>Service Information</b>	Date: <b>3/25/2026</b>
Profile: <b>EW180C Volvo</b>			

## Electrical system, specifications

Showing Selected Profile

<b>Valid for serial numbers</b>			
<b>Model</b>	<b>Production site</b>	<b>Serial number start</b>	<b>Serial number stop</b>
EW180C Volvo			

<b>Electrical system</b>	
System voltage	24 V

Document Title: <b>Engine control unit E-ECU, specifications</b>	Function Group: <b>030</b>	Information Type: <b>Service Information</b>	Date: <b>3/25/2026</b>
Profile: <b>EW180C Volvo</b>			

## Engine control unit E-ECU, specifications

Showing Selected Profile

Valid for serial numbers			
Model	Production site	Serial number start	Serial number stop
EW180C Volvo			

### E-ECU pin, specifications

Pin No.	Description	Pin No.	Description
A7	Feed to sensor (5 V)	B3	Engine oil level, low
A11	Signal ground to sensor	B4	Engine oil level, high
A12	Actuator MPROP common rail	B7	Preheating diagnostics coil
A15	Ambient filter ground	B8	Water in fuel, signal
A16	Actuator MPROP common rail ground	B10	Switch ground
A19	Rail pressure sensor	B11	Engine oil pressure, signal
A22	Boost pressure signal	B12	Exhaust pressure (Option)
A29	Air cleaner indicator	B15	Emergency switch (IVS)
A31	Oil temperature signal	B16	Fuel pressure, signal
A33	SAE J1587 B information bus	B17	Feed to sensor
A34	SAE J1587 A information bus	B18	Signal ground to sensor
A36	Injector cylinder 6	B23	Coolant level, signal
A37	Engine crank speed, plus (+)	B25	Preheating relay (coil)
A38	Engine crank speed, minus (-)	B27	Coolant temperature, engine, signal
A40	Injector cylinder 5	B30	Solenoid valve for IEGR
A44	Injector cylinder 4	B31	Ambient air temperature sensor
A45	Engine camshaft speed, plus (+)	B44	Exhaust temperature (Option)
A46	Engine camshaft speed, minus (-)	B51	SAE J1939 H control bus
A47	Boost temperature, signal	B55	SAE J1939 HL control bus
A48	Injector cylinder 3	B57	Voltage feed (ECU supply)
A52	Injector cylinder 2	B58	ECU ground
A56	Injector cylinder 1	B59	ECU ground
A57	ECU ground	B60	Voltage feed (ECU supply)
A59	Injector cylinder 1 ~ 3 (sv) — ground	B61	ECU ground
A60	Injector cylinder 4 ~ 6 (sv) — ground		

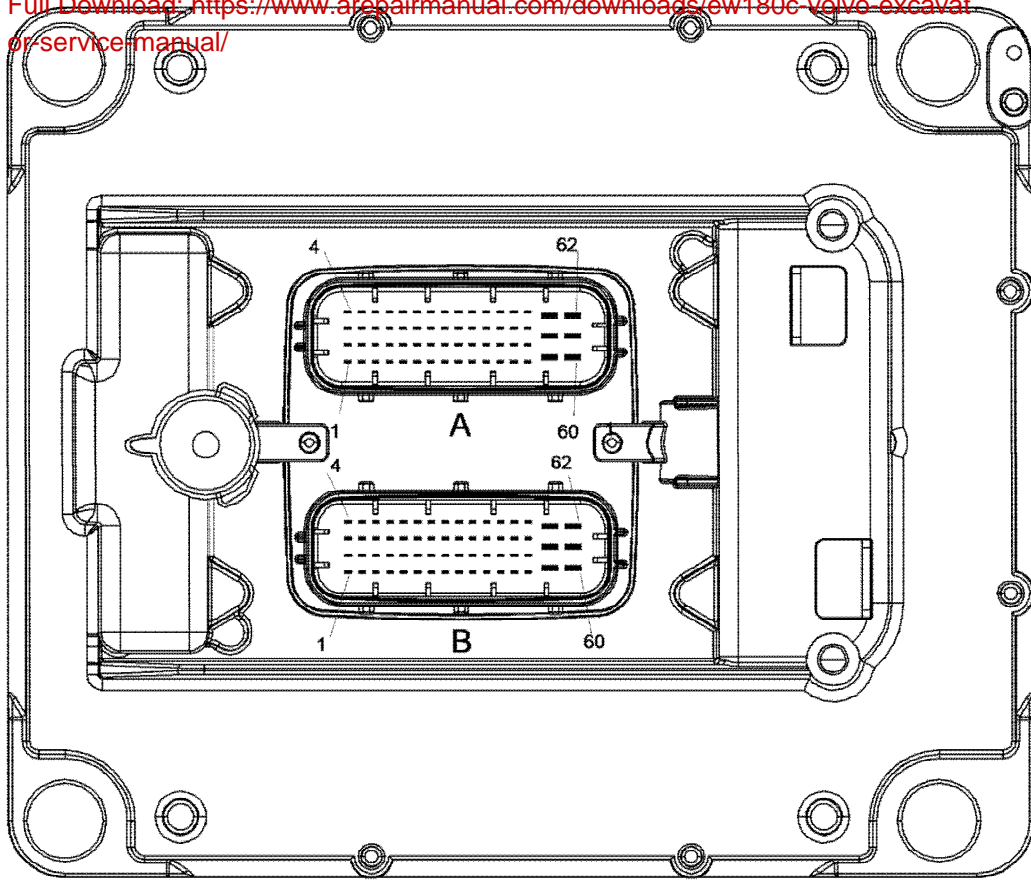

V1043756

**Figure 1**

E-ECU, connectors

- 
- |   |                          |
|---|--------------------------|
| A | 62 pin Tyco Connector, A |
| B | 62 pin Tyco Connector, B |