

Document Title: <b>Description EC620</b>	Function Group: <b>000</b>	Information Type: <b>Service Information</b>	Date: <b>3/18/2026</b>
Profile:			

## Description EC620

The machine is crawler excavator with a weight between 60.5 and 62.0 tonnes.

A standard machine consists of the following three main parts:

- superstructure
- undercarriage
- digging unit

### Superstructure frame with boom attachment, counterweight, machine housing and cab

The engine is a water cooled, six-cylinder, four-stroke, direct-injection, turbocharged diesel engine with an output of 284 kW (386 hp) and the type designation VOLVO PENTA TD121KG. The engine powers the hydraulic system of the excavator via a pump gearbox. Five pumps for the working hydraulics are connected to this gearbox on the standard version of the machine. A separate pump for the servo-hydraulic circuit is fitted on the diesel engine timing gear casing cover.

The machine has a 3-circuit hydraulic system with Åkerman priority system. The utilization of the pumps is controlled by a Mode selector through the following two programmes:

ECO = Economy (low speed, crawling)

CAP = Capacity (high speed, crawling)

The superstructure is slewed with the aid of an axial piston motor. Between engine and slewing ring there is a slew brake, gearbox and slewing pinion. The pinion runs against the internal teeth of the slewing ring. The slewing ring connects the superstructure with the undercarriage. A centre passage connects the superstructure and the undercarriage hydraulically.

The cab has ventilation filters and is prepared for air conditioning. The cab contains a computerised monitoring system for the diesel engine and the hydraulic system. Under the operator's seat there is also an electrical distribution box where most of the fuses and relays are positioned.

### Undercarriage with crawler unit and travel motors

Propulsion of the machine is achieved through two hydraulic motors driving the tracks. The motors are provided with hydraulic brakes. The brakes are negative, that is locked/applied by spring loading and only released when they are actuated by servo-pressure.

Rollers and idlers are greased for life.

### Digging equipment with boom, dipper arm and bucket

The digging equipment is connected to the superstructure frame through the boom attachment.

The boom cylinder movement is provided with float position for higher excavating speed and smoother operation.

A hose rupture valve is fitted on the boom cylinder.

Depending on choice of attachment, various combinations of boom, dipper arm and attachments are available.

This manual describes the most common alternatives.

Document Title: <b>Product Identification Signs</b>	Function Group: <b>000</b>	Information Type: <b>Service Information</b>	Date: <b>3/18/2026</b>
Profile:			

## Product Identification Signs

### Product Identification Signs and stamped-in markings for EC620

The adjacent illustrations, which do not apply to a specific machine model, show which signs and markings there are on the machine and where they can be found.

When ordering spare parts and in all enquiries by telephone or correspondence the model designation and the Reg. No. should always be stated.

When applicable the stamped-in data on separate components should also be stated.

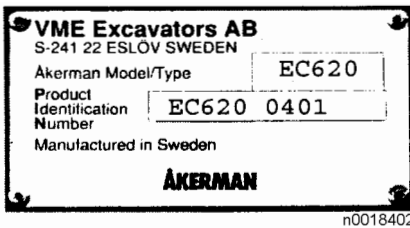

Figure 1

**Product identification sign** with model designation and number is positioned on the outside of the cab under the rear left side window.

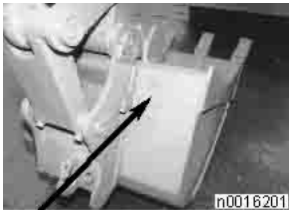

Figure 2

**The sign for the bucket** with part number, modification number, weight and capacity is positioned on top of the bucket to the left of the dipper arm attachment.

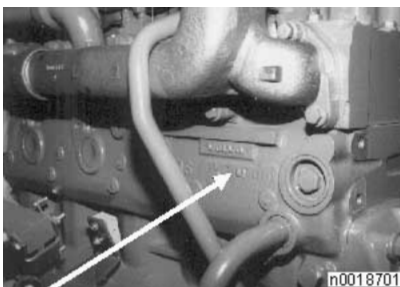
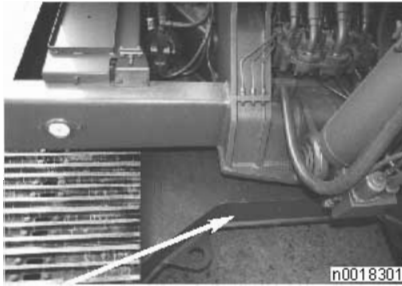

Figure 3

edge of the cylinder block (above the servo pump).



**Figure 4**

**The undercarriage part number** and modification number are stamped obliquely in front of and to the right of the slewing ring.

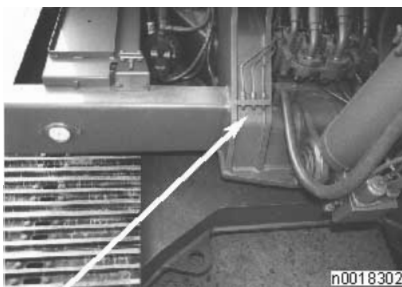

**Figure 5**

**The superstructure part number**, modification number and the machine Reg. No. are stamped into the right or the left boom attachment.

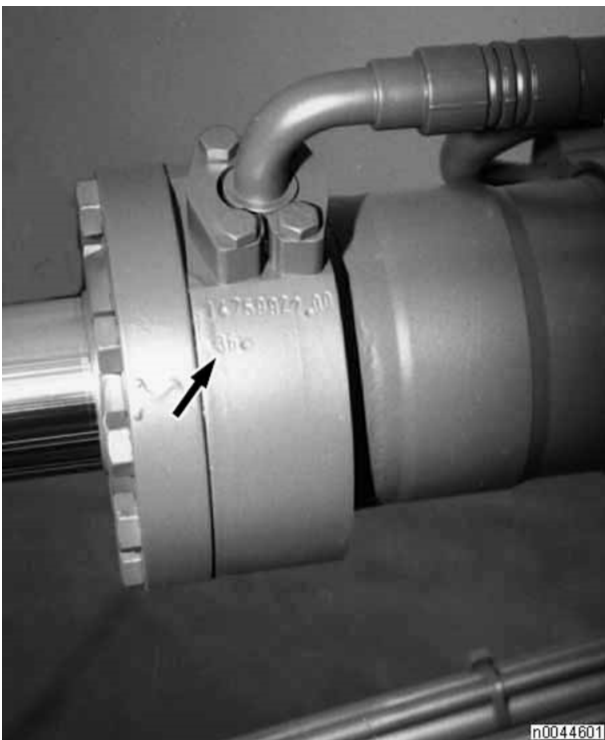

**Figure 6**

**The part number** and modification number **of the hydraulic cylinders** are stamped into the envelope surface of the

cylinder cover at the oil connection at the piston rod end of the cylinders.

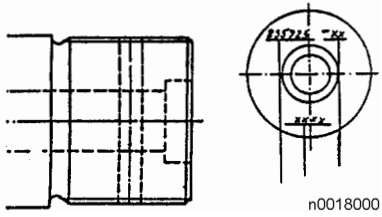

Figure 7

The **part number** and modification number **of the piston rods** are stamped into the end surface of the piston rods.

Document Title: <b>General</b>	Function Group: <b>030</b>	Information Type: <b>Service Information</b>	Date: <b>3/18/2026</b>
Profile:			

**General**

Max. tractive effort	480 kN (48.9 Mp)
Track speed, CAP	2.3 km/h (1.43 mph)
Track speed, ECO	2.3 km/h (1.43 mph)

Document Title: <b>Main dimensions</b>	Function Group: <b>030</b>	Information Type: <b>Service Information</b>	Date: <b>3/18/2026</b>
Profile:			

### Main dimensions

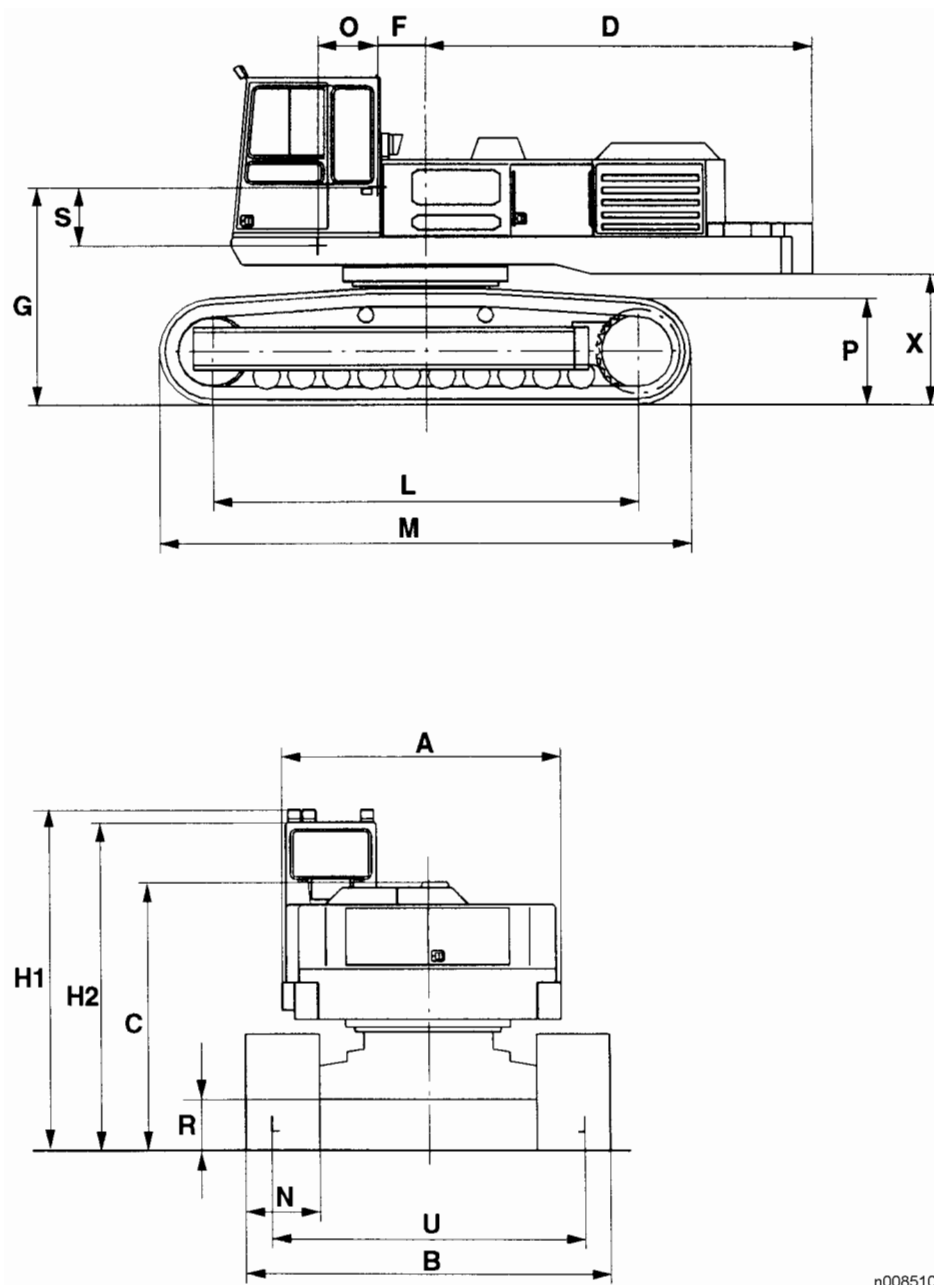

Figure 1

Document Title: <b>Tightening torques</b>	Function Group: <b>030</b>	Information Type: <b>Service Information</b>	Date: <b>3/18/2026</b>
Profile:			

## Tightening torques

### Tightening torques for nuts and bolts of steel

This standard applies when tightening with a torque wrench under the following conditions:

Condition No.	Surface finish (see below table)		Lubrication condition
	Bolt	Nut	
1	Unt	Unt	Oiled
2	Phos.	Unt. or Phos.	Oiled
3	Gzb	Unt. or Gzb	Dry
4	Gzv	Unt. or Gzb	Oiled

Unt. = Untreated  
 Phos. = Phosphatized  
 Gzb = Bright galvanized  
 Gzv = Hot galvanized

**When machine-tightening (using a nut runner) the tightening torque shown in the tables must be reduced by approx. 5% because of the greater variation of the obtained torque and thus to avoid reaching the yield point of the bolt.**

**When the supporting surface has a hardness lower than 200 HB a washer should be positioned under both bolt head and nut, in order to reduce the risk of settlement in the material with consequent reduction of the prestressing force.**

**When fitting, the tightening should be made to the prescribed torque without stopping in order to avoid that the higher static friction releases the torque wrench at a too low tightening.**

### Recommended tolerances for tightening torque

TIGHTENING TORQUES in Nm (lbf ft)	Tolerance
-50 (37)	±2
51–100 (37.5 – 73.5)	±5
101–200 (74 – 147)	±10
201–400(148 – 295)	±20
401–1000 (296 – 738)	±40
1001– (739 – )	±50

Thread M	Tensile strength class					
	8.8			10.9		12.9
	Mv in Nm (lbf ft) Condition No.			Mv in Nm (lbf ft) Condition No.		Mv in Nm (lbf ft) Condition No.
	1	2	3	1	2	1
M6	10 (7.4)	10 (7.4)	10 (7.4)	15 (11.1)	12 (8.9)	20 (14.8)
M8	25 (18.4)	25 (18.4)	25 (18.4)	35 (25.8)	30 (22.1)	40 (29.5)
M10	50 (37)	45 (33.2)	50 (37)	65 (48)	55 (41)	80 (59)
M12	80 (59)	80 (59)	90 (66)	120 (89)	100 (74)	140 (103)
M14	130 (96)	125 (92)	140 (103)	180 (135)	160 (118)	220 (160)

M16	200 (150)	190 (140)	210 (155)	280 (210)	240 (180)	340 (250)
M20	390 (290)	370 (270)	420 (310)	540 (400)	470 (350)	650 (480)
M22	520 (380)	500 (370)	560 (410)	730 (540)	630 (470)	880 (650)
M24	670 (490)	640 (470)	720 (530)	940 (690)	800 (590)	1120 (830)
M30	1310 (970)	1260 (930)	1400 (1030)	1840 (1360)	1580 (1170)	2210 (1630)
M36	2280 (1680)	2190 (1620)	2440 (1800)	3210 (2370)	2760 (2040)	3850 (2840)

Thread UNC	Tensile strength class					
	8.8			10.9		12.9
	Mv in Nm (lbf ft) Condition No.			Mv in Nm (lbf ft) Condition No.		Mv in Nm (lbf ft) Condition No.
	1	2	3	1	2	1
1/4	10 (7.4)	10 (7.4)	10 (7.4)	15 (11.1)	13 (9.6)	20 (14.8)
5/16	20 (14.8)	20 (14.8)	20 (14.8)	30 (22.1)	25 (18.4)	40 (29.5)
3/8	40 (29.5)	35 (25.8)	40 (29.5)	55 (41)	45 (33.2)	70 (52)
7/16	60 (44)	60 (44)	65 (48)	90 (66)	75 (55)	110 (81)
1/2	100 (74)	90 (66)	100 (74)	130 (96)	110 (81)	170 (125)
9/16	140 (103)	130 (96)	140 (103)	190 (140)	160 (118)	240 (180)
5/8	190 (140)	180 (135)	200 (150)	260 (190)	220 (160)	330 (240)
3/4	320 (240)	310 (230)	350 (260)	460 (340)	390 (290)	570 (420)
1	770 (570)	740 (550)	830 (610)	1090 (800)	940 (690)	1360 (1000)
1 1/8	1090 (800)	1050 (770)	1170 (860)	1550 (1140)	1330 (980)	1930 (1420)
1 1/4	1530 (1130)	1470 (1080)	1640 (1210)	2160 (1590)	1860 (1370)	2690 (1980)
1 3/8	2020 (1490)	1940 (1430)	2160 (1590)	2850 (2100)	2450 (1810)	3550 (2620)
1 1/2	2650 (1950)	2550 (1880)	2840 (2090)	3750 (2770)	3230 (2380)	4680 (3450)

When converting from N to kp: 1N = 0,1020 kp

Document Title: <b>Weights</b>	Function Group: <b>030</b>	Information Type: <b>Service Information</b>	Date: <b>3/18/2026</b>
Profile:			

## Weights

Basic machine with 700 mm (27.6 in) track (excl. digging equipment)	48400 kg (106.72 lbs)
Superstructure, incl. counterweight and diesel engine	approx. 24400 kg (21.296 lbs)

### Operating weights and ground pressure for complete excavator with:

7.3 m boom, 3.0 m dipper, 3060 l bucket and 10600 kg counterweight, 85 kg (187 lb) quickfit, full tank and driver.

Track width	Ground pressure	Total weight
800 mm	73.7 kPa (0.75 kp/cm <sup>2</sup> )	60.5 tonnes (133.378 lbs)
600 mm	95.8 kPa (0.98 kp/cm <sup>2</sup> )	59.0 tonnes (130.071 lbs)

Document Title: <b>Transportdata</b>	Function Group: <b>050</b>	Information Type: <b>Service Information</b>	Date: <b>3/18/2026</b>
Profile:			

## Transportdata

Transporting data in metres, feet and inches

<b>Boom length</b>	<b>7.3 (23' 11.4")</b>	
<b>Dipper arm length</b>	<b>3.0 (9' 10.1")</b>	<b>4.0 (13' 1.5")</b>
Overall length with digging equipment at full reach (D)	13.24 (43' 5.3")	13.30 (43' 7.6")
Front position of center of gravity to slewing center with retracted digging equipment (C)	4.22 (13' 10.1")	4.36 (14' 3.7")
Max. transporting height with retracted digging equipment(B)	16.92 (55' 6.1")	17.42 (57' 1.8")
Min. transporting length with retracted digging equipment (A)	-	-

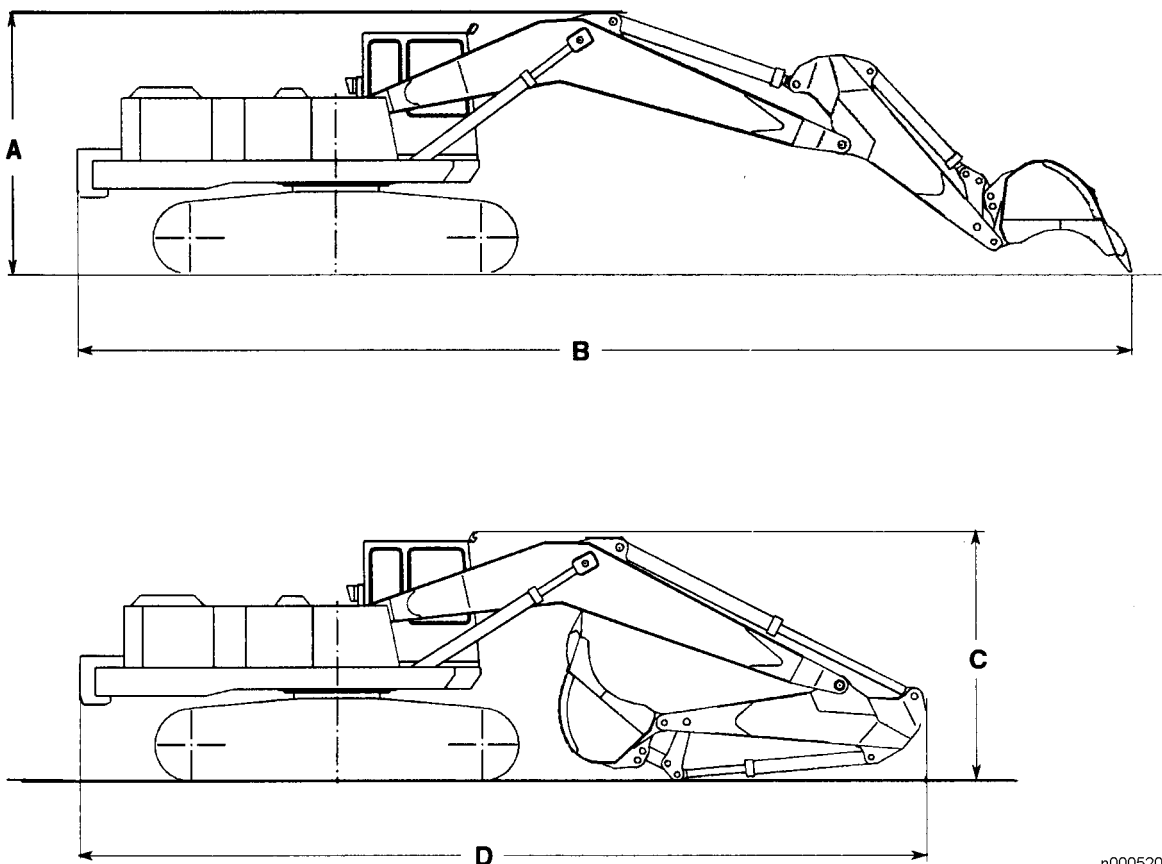

n0005200

**Figure 1**

Document Title: <b>Recommendations hydraulic oil</b>	for <b>160</b>	Function Group:	Information Type: <b>Service Information</b>	Date: <b>3/18/2026</b>
Profile:				

## Recommendations for hydraulic oil

Type of oil	Viscosity	Ambient temperature	Compatibility	Remark
SHS 32	ISO VG 32 HR	-30 till +35 °C	Mixable with SHS 46	
SHS 46	ISO VG 46 HR	-15 till +50 °C	Mixable with SHS 32	
PANOLIN HLP SE SYNTH 46 (Biodegradable)	Same as for mineral oil	-15 till +50 °C	Mixable with mineral oil but not other synthetic oils	Before changing from mineral oil to synthetic oil - contact Volvo Construction Equipment - Service
BP BIOHYD SE 46 (Biodegradable)	Same as for mineral oil	-15 till +50 °C	Mixable with mineral oil but not other synthetic oils	Before changing from mineral oil to synthetic oil - contact Volvo Construction Equipment - Service

The machine is normally delivered with oil of typ the SHS 46.

Document Title: <b>Dieseling in hydraulic cylinders</b>	Function Group: <b>173</b>	Information Type: <b>Service Information</b>	Date: <b>3/18/2026</b>
Profile:			

## Dieseling in hydraulic cylinders

If hydraulic oil mixed with air is compressed, the temperature rises and at a certain temperature some of the oil evaporates and ignites, thus so called dieseling takes place.

Dieseling causes burned piston seals and rings.

This problem is avoided if, after repairs, the lines to the hydraulic cylinders are vented in the following way. The hydraulic cylinders should be operated between end of stroke positions until the air is removed from the system. The load on the hydraulic system must be kept very low, while the air is being removed.

The dipper arm and bucket cylinders should be positioned so that any air will rise and gather at the outlet end of the cylinder. This means that the outlet end should be the highest point.

The piston should be at the opposite end of the cylinder. Wait a minute or so from the moment the cylinder is placed in this position, before you run the piston towards the outlet side.

Repeat this procedure several times (for instance three to five times).

Boom cylinders, which cannot be positioned as described above, must be run in and out about five times without any load in the bucket.



If the cylinders become pressurised through lifting the machine or lifting a load in the bucket before the air in the system has been removed, the seals will probably be damaged.

If a cylinder is to be pressure-tested after it has been repaired, the piston rod should be run in and out a few times, before the pressure is increased up to the test pressure.

Document Title: <b>Filtering hydraulic oil</b>	Function Group: <b>173</b>	Information Type: <b>Service Information</b>	Date: <b>3/18/2026</b>
Profile:			

## Filtering hydraulic oil

### Op nbr

[14031832 Filtering unit](#)

Consumables: Disposable filter 14025665

### Filtering must be carried out in the following cases:

- After major work on the hydraulic system for example work on the valve block, when changing tank and in cases of breakdown of a pump, hydraulic motor or a cylinder.
  - After a test has proven that the oil is contaminated.
  - On machines with re-occurring malfunctions of the hydraulic system.
1. Secure the filtering unit to the hydraulic tank. The unit is secured with the bolts for the hydraulic tank filter cover.
  2. Warm up the hydraulic oil to 35 °C if needed. Stop the diesel engine.
  3. Remove the protective caps A and B from the top of the hydraulic tank.
  4. Connect the suction line of the filtering unit to connection B and the return line to connection A, marked in the figure.

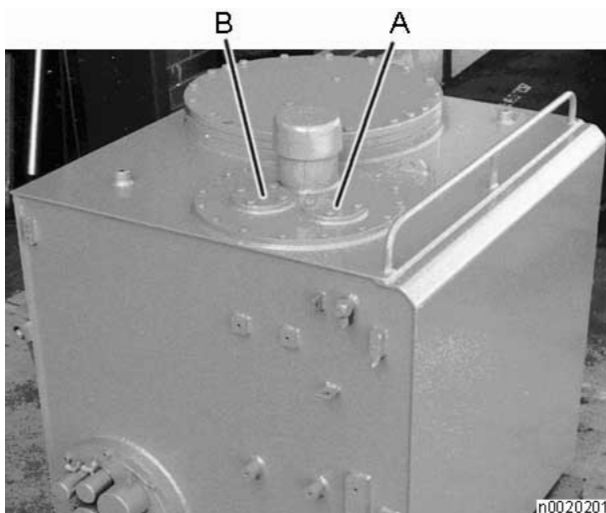

**Figure 1**

5. Start the filtering unit and run the hydraulic oil in the tank through the unit for approx. one hour.
6. Change the filter in the tank if the hydraulic oil was heavily contaminated.
7. Start the diesel engine and continue the filtering for a further two hours while operating the hydraulic functions of the machine. Make sure that all hydraulic functions are activated so that the oil in the entire system is filtered. Carry out the movements carefully so that the filtering unit is not dislocated from the tank.

8. Remove the filtering unit and re-fit the blind flanges to the tank.

After the filtering unit has been used, its filter container should be cleaned and a new disposable filter fitted.

Document Title: <b>Instructions for shrinking</b>	Function Group: <b>173</b>	Information Type: <b>Service Information</b>	Date: <b>3/18/2026</b>
Profile:			

## Instructions for shrinking

1. General[Invalid linktarget]
2. Equipment[Invalid linktarget]
3. Heating[Invalid linktarget]
4. Assembling[Invalid linktarget]
5. Dismantling[Invalid linktarget]

### 1. General

By "shrinkage fit" is meant that, at a certain temperature difference and a consequent change in measurements, a shaft and a hub can be assembled and become fixed when the temperature of the heated part drops and its size shrinks.

Usually the shaft is kept at room temperature, or preferably below, whereas the hub is heated in different ways. This method used, for instance, when fitting a gear wheel to a shaft, is described below.

### 2. Equipment

- a. Heating equipment  
A gas burner with an adequate nozzle or an electric hot plate with an output of approx. 1500 - 2000 W, and a diameter of approx. 250 mm (10 in).
- b. Measuring equipment  
A shrinkage gauge Part.no. 14194288 for checking the correct measurement change in the hub.

### 3. Heating

Prior to heating, make sure that the hub and shaft are free from burrs and defects that might otherwise impede the assembling of the parts.

- a. Hot plate:  
Heat the gear wheel on the plate until the shrinkage gauge can be easily pushed into the hub. Avoid exposing the measuring pin to heat or cold, as this will change its measurement. We recommend cooling the gauge to room temperature in between the times the gauge is used.
- b. Gas flame:  
Concentrate the heating to a circular area around the hub corresponding to about half of the gear wheel diameter, see Fig. 1. If the heat around the hub is to result in an increase in the diameter of the hole, some heat has to be added to the outer edge of the gear wheel. This has to be done with care so as not to damage the hardening of the gear teeth. Proceed with the heating of the gear wheel until the shrinkage gauge can be easily inserted in the hub.

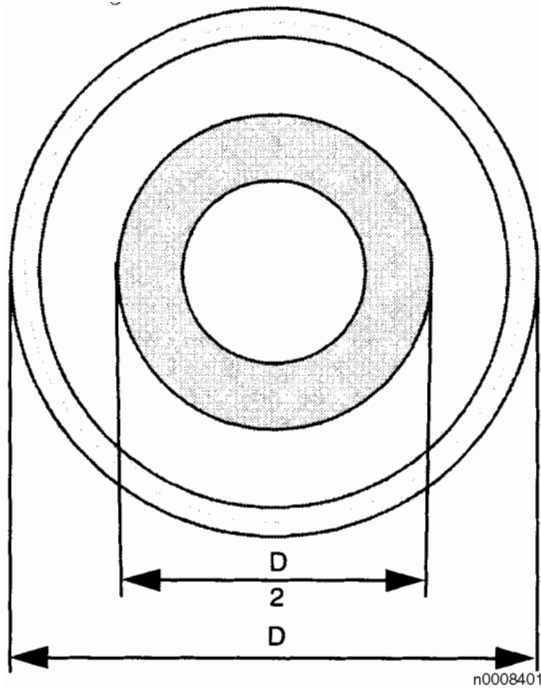

**Figure 1**

#### **4. Assembling**

Once the assembling has been started, the parts should be assembled as quickly as possible, to avoid heat from being transferred to the shaft, thus making assembling difficult or causing the parts to jam before they are correctly assembled. It is also important that the shaft is securely fixed in a vertical position in case the gear wheel should jam in an oblique position. With the shaft securely fixed it is easier to wriggle off the gear wheel quickly. If the gear wheel becomes fixed to the shaft before it is in its correct position, try to separate the wheel from the shaft as quickly as possible. If this is not possible, allow the parts to cool and proceed as described in the paragraph "Dismantling".

#### **5. Dismantling**

Try to press the shaft out of the hub without heating the hub. If this fails, apply pressure to the shaft in a hydraulic press. Gradually heat the hub, while the parts are fitted in the press, until the shaft loosens. If the heat is transmitted into the shaft, the shaft diameter increases with the risk that the fit will become too tight, thus making dismantling impossible. If the parts tend to bind because of the heat being transmitted into the shaft, stop the operation and cool off the parts. Then make a new dismantling attempt.

Document Title: <b>Instructions for vacuum pump</b>	Function Group: <b>173</b>	Information Type: <b>Service Information</b>	Date: <b>3/18/2026</b>
Profile:			

## Instructions for vacuum pump

Special tool: Vacuum pump 14 190 806

### **! WARNING**

**When working on the hydraulic system of the machine, avoid contact with leaking hydraulic oil under pressure. Also avoid contact with hot hydraulic oil.**

#### Fitting

### **! CAUTION**

The diesel engine must never be running when the sealing boot is blocking the breather filter of the hydraulic tank as this might cause serious damage to the pump.

- Place the pump on the hydraulic oil tank.
- Connect the plug to the 24 Volt socket on the machine and route the cable so that it will not be pinched anywhere.
- Fit the sealing boot on the cap for the breather filter of the hydraulic tank and connect the hose from the pump to the sealing boot as shown in the picture.

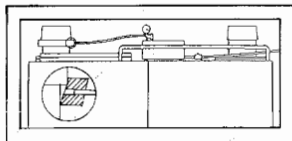

**Figure 1**

- Start the pump with the switch and adjust the valve so that the partial vacuum **never** exceeds 300 millibar (8.86 in Hg).

### **! CAUTION**

If the partial vacuum exceeds 300 mb (8.86 in Hg), there is a risk that the gearbox oil may be sucked into the hydraulic system and that the hydraulic oil tank may be damaged.

#### Removing

- Turn off the current for the pump with the switch.
- Remove the hose from the sealing boot and then remove the sealing boot from the hydraulic oil tank cap.
- Remove the plug from the 24 V socket on the machine.
- Remove the pump

Document Title: <b>Instructions for work with the electrical system</b>	Function Group: <b>173</b>	Information Type: <b>Service Information</b>	Date: <b>3/18/2026</b>
Profile:			

## **Instructions for work with the electrical system**

1. Fully charged and otherwise serviceable batteries should always be used when testing the electrical system. If the batteries are not fully charged, they should be charged or replaced by new ones.
2. Test the batteries with an acid tester and a cell tester. The battery disconnecter should be turned off.
3. When fitting a new battery: always take care so that the battery is connected with the correct polarity.
4. When changing batteries, these should have the same capacity and voltage, e.g. two 60 Ah and 12 V. The batteries must be equally old (have the same capacity) this is because the required charging current for the battery to reach a certain voltage changes with the age of the battery.
5. If a booster battery is necessary to start the engine, the instructions in the Section "SAFETY" must be followed unconditionally.[Invalid linktarget]
6. Before testing the alternator or the regulator, the batteries and the electrical leads must first be checked for insulation, poor contact and corrosion.  
Check the alternator belt.  
.All faults listed above must be rectified before checking the electrical system.
7. When checking the alternator, use "safe" connections. If a lead should work loose during the test, both the alternator and the regulator be destroyed.
8. If the output terminal on the alternator is earthed, the alternator will be and the regulator may be damaged.
9. Never disconnect the main lead from the alternator or the field winding lead while the engine is running, as this may damage both alternator and regulator.
10. When removing or fitting components in the electrical system, always disconnect the negative lead from the battery first.
11. Never disconnect any leads from the electronic control unit when the power supply to the unit is on, as this may damage it.

Document Title: <b>Recommendations for cleanliness when working on hydraulic systems</b>	Function Group: <b>173</b>	Information Type: <b>Service Information</b>	Date: <b>3/18/2026</b>
Profile:			

## Recommendations for cleanliness when working on hydraulic systems



### **WARNING**

**When working on the hydraulic system of the machine, avoid contact with leaking hydraulic oil under pressure. Also avoid contact with hot hydraulic oil.**

It is very important to keep the hydraulic system free from impurities, as these can cause abnormal wear and can lead to operation interruptions, which in turn means increased costs for service and repairs. In spite of the built-in filters in the system, the greatest cleanliness should be exercised when handling hydraulic components, oils and fluids.

#### **NOTE!**

When works are carried out on the hydraulic system the use of a vacuum pump is recommended.

The recommendations are grouped under the following headings:

1. Repairing hydraulic components in a workshop.[Invalid linktarget]
2. Work on hydraulic system carried out in a workshop.[Invalid linktarget]
3. Work carried out on hydraulic system on site.[Invalid linktarget]
4. Storing and transporting hydraulic components.[Invalid linktarget]
5. Storing and handling hydraulic oil.[Invalid linktarget]

### **1. Repairing hydraulic components in a workshop**

- Work on hydraulic components should be carried out separately from other workshop activities in a so called "clean room".
- The room should be well ventilated and the floor coated with an adherent (to dust) material. Machining, grinding etc must not be done in the "clean room".  
The work place should be equipped with thoroughly cleaned tools and suitable vessel for cleaning of hydraulic components. Avoid the use of adjustable spanners and wrenches.
- A vessel used for cleaning hydraulic components must not be used for cleaning anything else. The vessels should be cleaned often and new cleaning solution filled. The vessels should be equipped with a grating, to separate components from any sludge at the bottom.
- Components handled in the "clean room" should always be prewashed first. Lye solutions or similar which cause rusting must not be used as a cleaning agent.
- Work on the hydraulic system should always be planned so that it can be completed without delay.
- When cleaning parts while repairing, dry and clean compressed air should be used for drying, not cotton waste or rags. A low-pressure nozzle should preferably be used.
- When the repair of component has been completed, the components should always be plugged with clean plastic plugs of suitable size after which the component should be wrapped up.
- When cleaning the "clean room" a cleaning method should be used which does not stir up the dust and dirt.
- Hands and clothes should always be free from dirt.

### **2. Work on hydraulic system carried out in a workshop**

- The machine should be cleaned before it is taken into the workshop.
- The work place should be thoroughly tidied and the tools thoroughly cleaned and free from burrs.
- The machine should be screened from other machines or work places where welding or grinding is carried out. Any place where the hydraulic system is opened should be thoroughly cleaned and protected with plastic sheeting.
- The openings in components removed from the machine and those left open on the machine should be immediately plugged. The components should be placed in suitable containers wrapped in plastic sheeting. No welding may be carried out on the machine because of fire hazard when the hydraulic system has been opened.

- The components removed from the machine, which are to be repaired, should be cleaned before they are taken into the "clean room".
- Oil drained from the machine should be filled into a vessel intended for waste oil and this oil should not normally be re-used.
- If the tank is to be emptied and the oil on visual inspection or testing is found to be free from discolouration and impurities, fill the oil into a clean vessel which is then sealed. Refilling of this oil or filling with new oil should always be done with the hand pump on the machine.
- When refitting a component, the part of the machine where it is to be fitted should be thoroughly cleaned and inspected. In cases of frequent breakdowns and highly contaminated oil and components, pipes, hoses and valves should be flushed through and blown clean.
- Hands and clothes should always be free from dirt.

### **3. Work on hydraulic system carried out on site**

- When necessary and if possible the machine should be moved to as dust-free an environment as possible. Or, as an alternative, the machine should be screened off with plastic sheeting or similar.
- A thorough trouble shooting should be carried out to eliminate unnecessary work. Test the movements of the hydraulic functions, check pressures and engine speed and listen. Adjustable spanners or wrenches should not be used when working on the hydraulic system. When the trouble has been traced, the place of approach should be cleaned and plastic sheeting placed so that it protects against dirt.
- Exchange components should be used to avoid repairs on site.
- Openings on components removed from the machine and all openings left open on the machine should be immediately plugged. Components removed from the machine should be wrapped in plastic sheeting and placed in suitable containers. Components which are to be re-fitted should be stored fitted with protective plugs and kept in plastic foil in plastic containers.
- Oil drained from the machine should be poured into vessels intended for waste oil and this oil should normally not be re-filled.
- If the tank is to be drained and the oil is found to be reusable, it should be drained into a clean vessel which is then sealed. Always use the hand pump on the machine when refilling oil or filling new oil.
- Always use a suitable cleaning solution which should be poured into a thoroughly clean vessel.
- Working clothes and hands should always be clean from dirt. If you have to climb onto the machine make sure your shoes are thoroughly clean.
- After each completed operation the tools should be thoroughly cleaned and deburred if needed.

### **4. Storing and transporting hydraulic components**

- All hydraulic components should be stored in plastic bags or plastic sheeting and should be plugged. The wrapping should not be opened before the component is about to be used.
- Service vans should be fitted out and equipped in a way which facilitates order and cleanliness.
- Components which are too large to fit into the plastic containers should not be transported in the service vans but carried on a trailer instead.
- Each service van should carry a roll of plastic sheeting, plastic plugs of the most common sizes and types and plastic containers for components. Plugs and plastic sheeting should be of the disposable type.

### **5. Storing and handling hydraulic oil**

- The hydraulic oil should be stored either in tanks or drums which can be sealed. The place where the oil is drained from the storage containers should not be near where machining or welding is carried out.
- All filling with oil should be done with the hand pump of the machine.
- Before filling, always check the new oil for contamination by water or other impurities. Carry out a visual check of the oil poured into a glass.
- A container used for transporting hydraulic oil should only be used for this purpose. The vessel should be marked and cleaned often.
- At the slightest suspicion of contamination, samples should be taken and sent away for analysis. Always clean the hydraulic oil immediately if the result of the analysis suggests this or if major work has been carried out on the hydraulic system.
- Only clean the tank if a layer of dirt has been deposited on the bottom of the tank. Otherwise flushing through is sufficient. The suction line should always be closed before cleaning is done by the use of a suitable cleaning agent.

Document Title: <b>A few simple safety rules when servicing</b>	Function Group: <b>191</b>	Information Type: <b>Service Information</b>	Date: <b>3/18/2026</b>
Profile:			

### A few simple safety rules when servicing

The rules for operating the machine are given in the Operator's Instruction Manual. Read the following text for what must be done before you sit in the operator's seat to operate the machine and what must be done before and during the service of the machine.

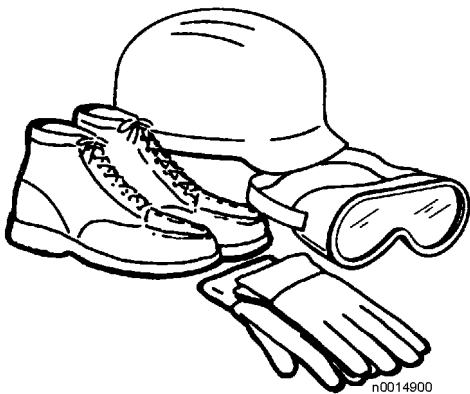

**Figure 1**

#### A few important rules:

Read all signs and instructions which are fitted onto the machine and which are given in the Operator's Instruction Manual before you begin to service the machine. Each of the instructions contains important information about the handling and servicing of the machine.

- Always wear a hard hat, safety glasses, gloves, protective shoes and other protective articles when the work demands it.  
Before starting the engine indoors, make sure that the ventilation is sufficient to cope with the exhaust gases.



**Figure 2**

- Carry out all checks which are prescribed. See the Operator's Instruction Manual under heading "How to start".

## CAUTION

The machine should be in service position A when the checks are carried out.

- Make a control lamp test before starting the engine. Turn the ignition key to position I, see the Operator's Instruction Manual. If the alarm lamp flashes, the machine must **NOT BE STARTED** until the fault has been rectified.
- If the horn begins to sound: **SWITCH OFF THE CURRENT IMMEDIATELY** The warning is triggered because the flap valve in the suction line for the pumps is closed.
- Never drive the machine while under influence of alcohol, medicine or other drugs.
- When you are entering or leaving the machine, always face the machine and use the steps and handles. Always use both hands and one foot or both feet and one hand. Do not jump!
- No work must be carried out on the machine until you have acquired the appropriate knowledge of the machine to do the work.
- Park the machine in service position A before carrying out any work on the hydraulic system. The hydraulic system can be highly pressurised in parts even if the engine is turned off. Take extra care when opening the system between valve and hydraulic cylinder or hydraulic motor.
- Service work which is not carried out in the correct way is dangerous. Make sure you have sufficient knowledge, correct information, correct tools and correct equipment to carry out the service in a correct way. Repair or change broken tools and equipment.
- Always stop the engine before servicing the machine unless otherwise instructed on signs or in service literature.
- When changing oil in the engine, hydraulic system or gearbox, remember that the oil may be hot and could cause burns.
- Make sure that handles and stepping surfaces on ladders and other parts of the machine are free from oil, dirt or ice.
- Never wear loose-fitting clothing, a scarf or jewelry, which can get caught and cause injury, when working on the machine.
- When carrying out service work on the undercarriage, the slew brake should be applied and the digging equipment lowered with the bucket resting on firm ground.
- If the undercarriage is raised with the aid of the digging equipment, safe supports should be placed under the raised part of the machine before any person is allowed into the dangerous area under the machine.
- No persons are allowed under the digging equipment when it is lifted.



**Figure 3**

- Do not drive any shafts or pivot pins out of the digging equipment without having first safely supported the parts involved or suspended them from approved and correctly dimensioned lifting equipment.
- When lifting or supporting components, use equipment with a lifting capacity which is at least as great as the weight of the component.

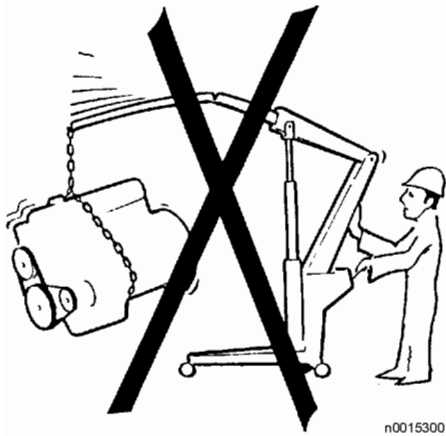

**Figure 4**

- All lifting devices such as strops, slings, ratchet blocks etc., must comply with appropriate National Regulations for such devices. **VCE Excavators will not accept any responsibility if any lifting devices, tools or working methods other than those described in this publication are used.**
- Stop the engine before opening doors, removing engine covers or similar. Make sure that no tools or other objects which can cause damage are left in the machine.



**Figure 5**

- Make sure that all doors and covers on the machine are closed before the engine is started and the machine put to work.
- All pressurised vessels must be opened very carefully.
- Be careful during all leak detection. An invisible jet of oil from a leak easily penetrates skin and causes severe injury to tissue. If an injury has arisen, seek medical advice immediately.
- Never set a pressure-limiting valve to a higher pressure than that recommended by the manufacturer.
- Persons are not allowed within the working range of the machine when the engine is running.

**Before you leave the operator's seat while the engine is running, the following precautions must be taken:**

1. Lower the digging equipment and rest the bucket on firm ground.
2. Make sure that the ignition key is turned on.
3. Apply the slew brake.
4. Lower the safety bar (the supply of servo pressure to the control levers interrupted).
5. Check that the left control lever is without pressure.

**If the machine is to be left unattended, the engine must be stopped and the ignition key removed.**

Document Title: <b>Air conditioning</b>	Function Group: <b>191</b>	Information Type: <b>Service Information</b>	Date: <b>3/18/2026</b>
Profile:			

## Air conditioning

### Competence and authorization

To handle refrigerants workshops must have authorization. An authorized workshop must have at least one person in supervising position holding a certificate. Authorization is applied for at national authorities according to the laws of the country.

### Service equipment

Pressure vessels, filling apparatus, vacuum pump and hoses etc. that are being used for one refrigerant must never get into contact with another refrigerant. Also a very small amount of R12 have a very degrading effect on R134a. This in its turn can destroy components in the AC-system.

In all filling and emptying of refrigerants prescribed tools must be used.

### Refrigerant for a certain machine

At the service nipples there must be sign stating volume and type of refrigerant.

### NOTE!

The following two pages contains information of the same kind regarding two different refrigerants. Read the page that deals with the type of refrigerant used in your machine.

### Refrigerant R12

Take the greatest care in all work with refrigerant.

The AC system contains pressurised refrigerant. It is illegal to purposely release refrigerant into the open air. Any service, refilling (charging) or emptying (discharging) of refrigerant must be carried out by trained and qualified service personnel.

To protect the environment it is important that all service on the AC and all handling of refrigerant is carried out by an authorised VCE workshop.

The AC system is pressurised and refrigerant can unintentionally leak. Never loosen the filling plug on the compressor or hose and pipe unions. If a leak is suspected, do not try to refill the system.

**Contact an authorised VCE workshop for help.**



### **WARNING**

**Refrigerant used in the cooling unit can cause frostbite, if it comes into contact with bare skin. Therefore, in all handling of refrigerant the following points must be observed:**

- Use close-fitting goggles.
- Use rubber gloves and protect bare skin for the rest.



n9000100

**Figure 1**

- **The refrigerant vapour is heavier than air and will therefore sink to the floor.**
- Smoking, welding or other naked flames are not permitted in or around the place where work with refrigerant is carried out. The refrigerant vapour could be ignited, forming poisonous stuffs like **hydrochloric acid gas, hydrogen fluoride** and **phosgene** which are very dangerous to inhale.  
The gases formed when the refrigerant is heated have a pungent smell at high concentrations.  
**They can cause severe damage to the lungs even at low concentrations when no smell is evident.** The symptoms may arise several hours (even up to 24 hours) after exposure.  
Rescue party should wear fresh-air masks.

#### Recommended first aid

- When inhaled the refrigerant gas can have an effect mainly on the nervous system. In high concentrations the gas have a stunning effect. A person who has inhaled the gas should be taken out into fresh air and if necessary be given artificial respiration. Call for a doctor.
- In case of an accident where refrigerant comes into contact with bare skin - remove clothes and wash with lukewarm water.
- If refrigerant has got into the eyes - rinsed with water for at least 15 minutes. In case of persistent trouble - contact a doctor as soon as possible.

#### Refrigerant R134a

Take the greatest care in all work with refrigerant.

For environmental protection reasons a new refrigerant named R134a has been introduced as a replacement for R12. Opposite to this R134a has no degrading effect on the ozone layer but adds to the greenhouse effect. So it must never be let out in the open air. If repair is to be carried out in the AC system the refrigerant must be collected in pressure vessels for reuse or destruction.

The AC system is pressurised and refrigerant can unintentionally leak. Never loosen the filling plug on the compressor or hoses and pipe unions. If a leak is suspected, do not try to refill the system.

**Contact an authorised VCE workshop for help.**



**Refrigerant used in the cooling unit can cause frostbite, if it comes into contact with bare skin.**

**Therefore, in all handling of refrigerant the following points must be observed:**

- Use close-fitting goggles.
- Use rubber gloves and protect bare skin for the rest.



**Figure 2**

- **The refrigerant vapour is heavier than air and will therefore sink to the floor.**
- Smoking, welding or other naked flames are not permitted in or around the place where work with refrigerant is carried out. The refrigerant vapour could be ignited, forming poisonous stuffs like **fluorides** which are very dangerous to inhale. The gases formed when the refrigerant is heated have a pungent smell at high concentrations.  
**They can cause severe damage to lungs even at low concentrations when no smell is evident.** The symptoms may arise several hours (even up to 24 hours) after exposure.  
Rescue party should wear fresh-air masks.

**Recommended first aid**

- When inhaled the refrigerant gas can have an effect mainly on the nerv system. In high concentrations the gas have a stunning effect. A person who has inhaled the gasshould be taken out into fresh air and if necessary be given artificial respiration. Call for a doctor.
- In case of an accident where refrigerant comes into contact with bare skin - remove clothes and wash with lukewarm water.
- If refrigerant has got into the eyes - rinsed with water for at least 15 minutes. In case of persistent trouble - contact a doctor as soon as possible.

Document Title: <b>Charging batteries</b>	Function Group: <b>191</b>	Information Type: <b>Service Information</b>	Date: <b>3/18/2026</b>
Profile:			

## Charging batteries

### **WARNING**

When a battery is being charged, an explosive mixture of oxygen and hydrogen gas is formed. A short circuit, a naked flame or a spark in the neighbourhood of the battery can cause a powerful explosion.

Always turn off the charging current before disconnecting the charging clamps. Ventilate well, particularly if the battery is being charged in a confined space.

The battery electrolyte includes caustic sulphuric acid. Any electrolyte that is spilled on the skin should be removed immediately. Wash with soap and plenty of water. If electrolyte gets into your eyes or any other sensitive part of the body, rinse off immediately with plenty of water and contact a doctor straight away.

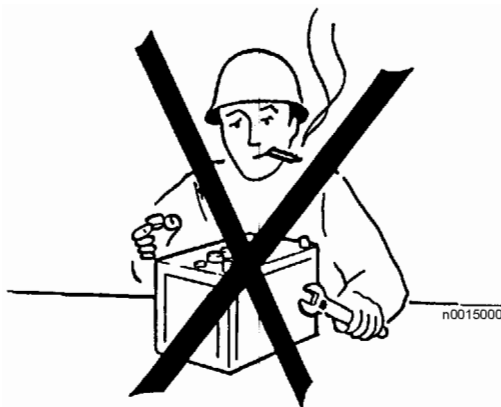

Figure 1

Document Title: <b>Handling spring package for track tensioner</b>	Function Group: <b>191</b>	Information Type: <b>Service Information</b>	Date: <b>3/18/2026</b>
Profile:			

## Handling spring package for track tensioner



**Keep away from the area in front of and behind the ends of the spring package when handling it. Parts may shoot out if there is a failure of the spring rod.**

Much energy is stored in the compressed spring of the spring package. This energy will be released in case of a failure of the spring rod.

The spring package is equipped with a built in guard to prevent accidents caused by a possible spring rod failure when handling the spring packages.

It is highly recommendable to place the bucket of the machine in front of the idler before opening the track chain.

Document Title: <b>Measures to prevent fire</b>	Function Group: <b>191</b>	Information Type: <b>Service Information</b>	Date: <b>3/18/2026</b>
Profile:			

## Measures to prevent fire

- There is always a risk of fire. Find out which type of fire extinguisher to use, where it is kept and how to use it.

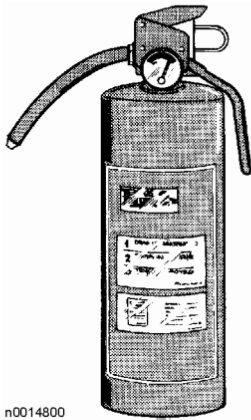

**Figure 1**

- At the slightest sign of fire, if the circumstances permit and bearing in mind your own safety, take the following steps:
  - Drive the machine away from the danger area.
  - Lower the digging equipment to the ground.
  - Stop the engine with the stop control and turn the ignition key to the "0" position.
  - Turn off the battery disconnect switch.
  - Start putting out the fire and notify the fire brigade if required.

### **CAUTION**

Any fire fighting equipment installed on the machine should be maintained in working order. Such extra equipment should be considered as an addition to the measures the operator can take in case of fire. The equipment should not be considered as a replacement for the operator's own fire fighting efforts.

- Smoking or an open flame are not permitted near a machine when filling fuel or when the fuel system has been opened.



**Figure 2**

- Diesel fuel oil is flammable and must not be used as a cleaning agent. Instead use an approved solvent.
- Remember that certain solvents can cause skin rashes and are usually flammable. Do not inhale solvent vapour.
- Store flammable starting aids in a cool, well ventilated location. Remember that such aids (starting gas) must not be used in combination with electrical preheating of the induction air.
- Keep the workplace clean. Cleanliness is of decisive importance for trouble-free operation of systems in the machine. Oil or water on the floor makes it slippery and also dangerous in connection with electrical equipment or electrically powered tools. Oily clothes are a serious fire hazard. Check daily that the machine and equipment are free from dirt and oil. In this way the risk of fire is reduced and it is easier to detect faulty or loose components.

### **! CAUTION**

If a high-pressure jet is used for cleaning, take great care as the electrical components and the insulation of electrical leads can become damaged even at a moderately high pressure and temperature. Protect electrical components and leads in a suitable manner. (Do not direct the water jet against the slewing ring seal).

- Keep the machine extra clean when working in a fire-sensitive environment, i.e. saw mill, rubbish dump or similar. To reduce the accumulation of easily combustible material when operating in such environments, the machine should be equipped with suitable equipment which reduces the accumulation of combustible material and the risk of such material igniting.
- Welding and grinding on the machine may only be carried out when it is placed in a clean area where there are no tanks containing combustible liquids, hydraulic pipes or similar lying around. Take extra care when welding and grinding near flammable objects. A fire extinguisher should be kept handy. The welding unit should be earthed as close as possible to the point of welding and to the same piece of material that is being welded. Also note that the earth lead should be disconnected from the battery when welding on the superstructure and installed parts.
- Check that electric leads have not been damaged by chafing. Also make sure that they cannot be damaged by chafing. This applies particularly to unfused leads for example leads between:
  - The batteries.
  - Battery and starter motor.
  - Battery disconnect switch and A1 fuse box (F1–F2)

**NOTE!**

NOTE: This lead is not disconnected by the battery disconnect switch.

- Battery disconnect switch and K2 main relay.
  - Alternator and starter motor.
  - Starter motor – K1 relay – preheating coil – starter motor.
- Check that the connecting strips from K2 to A1 are secure.
  - When unfused leads have been disconnected, it is important to check that they are reconnected and clamped in such a way that they cannot be exposed to chafing. Unfused leads must not lie against oil and fuel hoses.
  - Check that there is no damage to fuel, hydraulic and brake hoses caused by chafing.
  - When fitting any extra equipment, make sure that all leads (circuits) are connected across a fuse and routed and clamped so that there is no risk of chafing.