

Document Title: Description	Function Group: 000	Information Type: Service Information	Date: 10/25/2025
Profile:			

Description

The machine is crawler excavator with a weight between 23.0-24.0 tonnes.

A standard machine consists of the following three main parts:

- superstructure
- undercarriage
- digging unit

Superstructure frame with boom attachment, counterweight, machine housing and cab

The engine is a water cooled, six-cylinder, four-stroke, direct-injection, turbocharged diesel engine with an output of 122 kW (166 hp) and the type designation Volvo TD61GE. The engine powers the hydraulic system of the excavator via a pump gearbox. Three pumps for the working hydraulics are connected to this gearbox on the standard version of the machine. A separate pump for the servo-hydraulic circuit is fitted on the diesel engine timing gear casing cover.

The machine has triple-circuit hydraulics with Åkerman's priority system and COS (= Capacity Optimised System). Thereby all three pumps can be used for separate excavating movements. The utilisation of the pumps is controlled by a so called Mode Selector through the following three programmes:

- HLD = Heavy Lift Device
- ECO = Economy
- CAP = Capacity

The pumps are controlled through SSC[1] in order to avoid stalling of the diesel engine.

The superstructure is slewed with the aid of an axial piston motor. Between engine and slewing ring there is a slew brake, gearbox and slewing pinion. The pinion runs against the internal teeth of the slewing ring. The slewing ring connects the superstructure with the undercarriage. A centre passage connects the superstructure and the undercarriage hydraulically.

The cab has ventilation filters and is prepared for air conditioning. The cab contains a computerised monitoring system for the diesel engine and the hydraulic system. Under the operator's seat there is also an electrical distribution box where most of the fuses and relays are positioned.

Undercarriage with crawler unit and travel motors

Propulsion of the machine is achieved through two fixed or variable hydraulic motors driving the tracks. The motors are provided with hydraulic brakes. The brakes are negative, that is locked (applied) by spring loading, and only released when they are actuated by servo-pressure.

Rollers and idlers are greased for life.

Digging equipment with boom, dipper arm and bucket

The digging equipment is connected to the superstructure frame through the boom attachment.

The boom cylinder movement is provided with float position for higher excavating speed and smoother operation.

A hose rupture valve is fitted on the boom cylinder.

Depending on choice of attachment, various combinations of boom, dipper arm and attachments are available.

This manual describes the most common alternatives.

[1]Speed Sensing Control

Document Title: Product Identification Signs	Function Group: 000	Information Type: Service Information	Date: 10/25/2025
Profile:			

Product Identification Signs

Product Identification Signs and stamped-in markings for EC230B

The adjacent illustrations, which do not apply to a specific machine model, show which signs and markings there are on the machine and where they can be found.

When ordering spare parts and in all enquiries by telephone or correspondence the **model designation** and the **Reg. No** should always be stated.

When applicable the stamped-in data on separate components should also be stated.

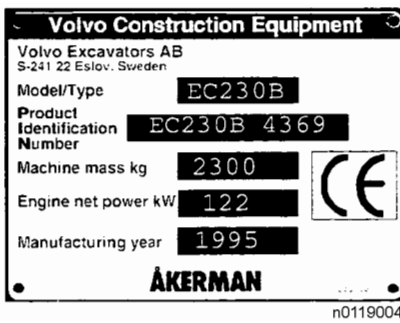

Figure 1

Product identification sign with model designation and number is positioned on the outside of the cab under the rear left side window.



Figure 2

The sign for the bucket with **part number, modification number, weight and capacity** is positioned on top of the bucket to the left of the dipper arm attachment.

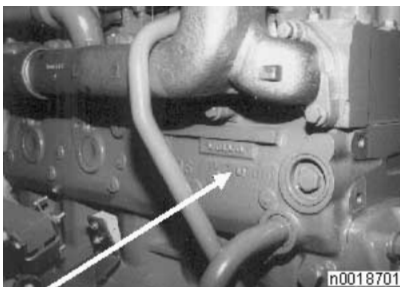

Figure 3

Sample of manual. Download All 344 pages at:

<https://www.aresairmanual.com/downloads/volvo-ec230b-excavators-service-manual/>

The **diesel engine type designation**, product and serial number are stamped onto the left side of the engine at the upper edge of the cylinder block.

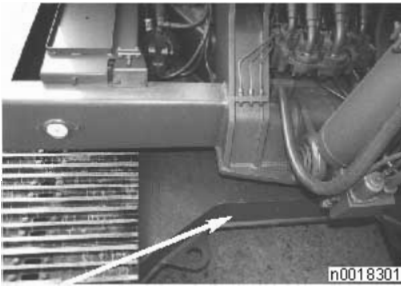

Figure 4

The **undercarriage part number** and modification number are stamped obliquely in front of and to the right of the slewing ring.

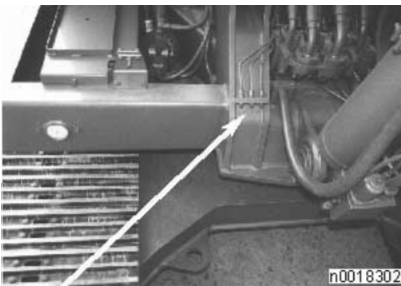

Figure 5

The **superstructure part number**, modification number and the machine Reg. No. are stamped into the right or the left boom attachment.

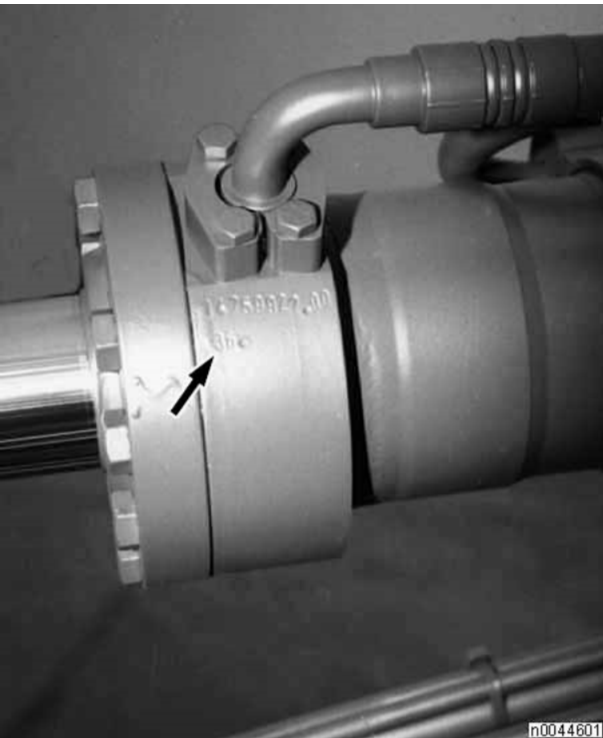

Figure 6

The **part number** and modification number **of the hydraulic cylinders** are stamped into the envelope surface of the cylinder cover at the oil connection at the piston rod end of the cylinders.

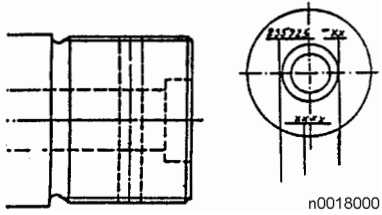

Figure 7

The **part number** and modification number **of the piston rods** are stamped into the end surface of the piston rods.

Document Title: Specification, general	Function Group: 030	Information Type: Service Information	Date: 10/25/2025
Profile:			

Specification, general

Max. tractive effort	222 kN (22.9 Mp)
----------------------	------------------

Track speed	Hydraulic motor	
	Fixed displacement	Variable displacement
CAP	3.3 km/h (2.05 mph)	5.1 km/h (3.17 mph)
ECO	2.5 km/h (1.55 mph)	3.9 km/h (2.42 mph)
HLD	2.5 km/h (1.55 mph)	2.5 km/h (1.55 mph)

Transporting data in metres (feet, inches)

Boom length	5.20 m (17, 0.7)		
Dipper arm length	2.25 (7, 4.6)	2.80 (9, 2.2)	3.30 (10, 9.9)
Min. transporting length with retracted digging equipment (D)	9.00 (29, 6.3)	9.00 (29, 6.3)	9.00 (29, 6.3)
Min. transporting height with retracted digging equipment (C)	3.20 (10, 5.9)	3.25 (10, 8.0)	3.90 (12, 10.7)
Overall length with digging equipment at full reach (B)	11.90 (39, 0.5)	12.30 (40, 4.2)	12.70 (41, 8.0)
Min. transp. height with digging equipment at full reach (A)	3.20 (10, 5.9)	3.20 (10, 5.9)	3.20 (10, 5.9)
Boom length	5.7 (18, 8.4)		
Dipper arm length	2.25 (7, 4.6)	2.80 (9, 2.2)	3.30 (10, 9.9)
Min. transporting length with retracted digging equipment (D)	9.75 (31, 11.9)	9.75 (31, 11.9)	9.60 (31, 5.9)
Min. transporting height with retracted digging equipment (C)	3.20 (10, 5.9)	3.25 (10, 8.0)	3.70 (12, 1.7)
Overall length with digging equipment at full reach (B)	12.55 (41, 2.1)	12.95 (42, 5.8)	13.40 (43, 11.6)
Min. transp. height with digging equipment at full reach (A)	3.15 (10, 4.0)	3.15 (10, 4.0)	3.15 (10, 4.0)

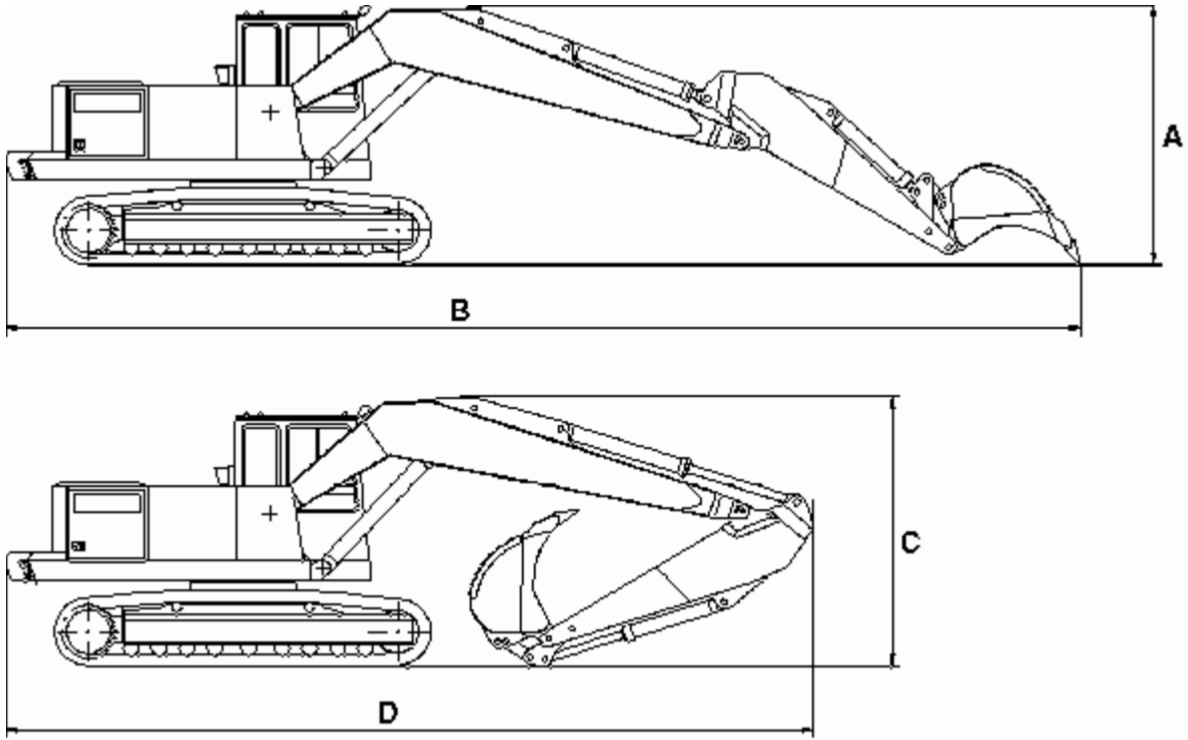

Figure 1

Document Title: Specifications, dimensions	Function Group: 030	Information Type: Service Information	Date: 10/25/2025
Profile:			

Specifications, dimensions

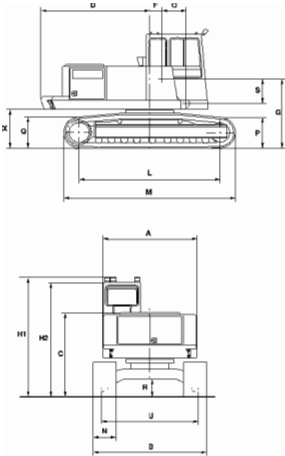

Figure 1

A	2.49 m / 8 ft 2.0 in
B	2.99 m / 9 ft 9.7 in
C	2.22 m / 7 ft 3.4 in
D	2.87 m / 9 ft 5.0 in
F	0.32 m / 1 ft 0.6 in
G	1.83 m / 6 ft 0.0 in
H1	3.15 m / 10 ft 4.0 in
H2	3.01 m / 9 ft 10.5 in
L	3.73 m / 12 ft 2.8 in
M	4.54 m / 14 ft 10.7 in
N	0.60 m / 1 ft 11.6 in
O	0.65 m / 2 ft 1.6 in
P	0.81 m / 2 ft 7.9 in
Q	0.83 m / 2 ft 8.7 in
R	0.47 m / 1 ft 6.5in
S	0.65 m / 2 ft 1.6 in
U	2.56 m / 8 ft 4.8 in
X	1.03 m / 3ft 4.6 in

Document Title: Tightening torques	Function Group: 030	Information Type: Service Information	Date: 10/25/2025
Profile:			

Tightening torques

Tightening torques for nuts and bolts of steel

This standard applies when tightening with a torque wrench under the following conditions:

Condition No.	Surface finish		Lubrication condition
	Bolt	Nut	
1	Untreated	Untreated	Oiled
2	Phosphatized	Untreated or Phosphatized	Oiled
3	Bright galvanized	Untreated or Bright galvanized	Dry
4	Hot galvanized	Untreated or Bright galvanized	Oiled

When machine-tightening (using a nut runner) the tightening torque shown in the tables must be reduced by approx. 5% because of the greater variation of the obtained torque and thus to avoid reaching the yield point of the bolt.

When the supporting surface has a hardness lower than 200 HB a washer should be positioned under both bolt head and nut, in order to reduce the risk of settlement in the material with consequent reduction of the prestressing force.

When fitting, the tightening should be made to the prescribed torque without stopping in order to avoid that the higher static friction releases the torque wrench at a too low tightening.

Recommended tolerances for tightening torque

Tolerance	TIGHTENING TORQUES in Nm (lbf ft)					
	-50 (37)	51-100 (37.5 - 73.5)	101-200 (74 - 147)	201-400 (148 - 295)	401-1000 (296 - 738)	1001- (739 -)
	± 2	± 5	± 10	± 20	± 40	± 50

Thread	Tensile strength class						Thread
	8.8			10.9		12.9	
	Mv in Nm (lbf ft)			Mv in Nm (lbf ft)		Mv in Nm (lbf ft)	
	Condition No.			Condition No.		Condition No.	
	1	2	3	1	2	1	
M6	10 (7.4)	10 (7.4)	10 (7.4)	15 (11.1)	12 (8.9)	20 (14.8)	M6
M8	25 (18.4)	25 (18.4)	25 (18.4)	35 (25.8)	30 (22.1)	40 (29.5)	M8
M10	50 (37)	45 (33.2)	50 (37)	65 (48)	55 (41)	80 (59)	M10
M12	80 (59)	80 (59)	90 (66)	120 (89)	100 (74)	140 (103)	M12
M14	130 (96)	125 (92)	140 (103)	180 (135)	160 (118)	220 (160)	M14
M16	200 (150)	190 (140)	210 (155)	280 (210)	240 (180)	340 (250)	M16
M20	390 (290)	370 (270)	420 (310)	540 (400)	470 (350)	650 (480)	M20
M22	520 (380)	500 (370)	560 (410)	730 (540)	630 (470)	880 (650)	M22
M24	670 (490)	640 (470)	720 (530)	940 (690)	800 (590)	1120 (830)	M24
M30	1310 (970)	1260 (930)	1400 (1030)	1840 (1360)	1580 (1170)	2210 (1630)	M30
M36	2280 (1680)	2190 (1620)	2440 (1800)	3210 (2370)	2760 (2040)	3850 (2840)	M36

Thread	Tensile strength class						Thread
	8.8			10.9		12.9	
	Mv in Nm (lbf ft)			Mv in Nm (lbf ft)		Mv in Nm (lbf ft)	
	Condition No.			Condition No.		Condition No.	
	1	2	3	1	2	1	
1/4	10 (7.4)	10 (7.4)	10 (7.4)	15 (11.1)	13 (9.6)	20 (14.8)	1/4
5/16	20 (14.8)	20 (14.8)	20 (14.8)	30 (22.1)	25 (18.4)	40 (29.5)	5/16
3/8	40 (29.5)	35 (25.8)	40 (29.5)	55 (41)	45 (33.2)	70 (52)	3/8
7/16	60 (44)	60 (44)	65/48	90 (66)	75 (55)	110 (81)	7/16
1/2	100 (74)	90 (66)	100 (74)	130 (96)	110 (81)	170 (125)	1/2
9/16	140 (103)	130 (96)	140 (103)	190 (140)	160 (118)	240 (180)	9/16
5/8	190 (140)	180 (135)	200 (150)	260 (190)	220 (160)	330 (240)	5/8
3/4	320 (240)	310 (230)	350 (260)	460 (340)	390 (290)	570 (420)	3/4
1	770 (570)	740 (550)	830 (610)	1090 (800)	940 (690)	1360 (1000)	1
1 1/8	1090 (800)	1050 (770)	1170 (860)	1550 (1140)	1330 (980)	1930 (1420)	1 1/8
1 1/4	1530 (1130)	1470 (1080)	1640 (1210)	2160 (1590)	1860 (1370)	2690 (1980)	1 1/4
1 3/8	2020 (1490)	1940 (1430)	2160 (1590)	2850 (2100)	2450 (1810)	3550 (2620)	1 3/8
1/2	2650 (1950)	2550 (1880)	2840 (2090)	3750 (2770)	3230 (2380)	4680 (3450)	1 1/2

Mv = Tightening torque

When converting from N to kgf: 1 N = 0.1020 kg

When converting from N m to lbf ft, multiply the Nm value by 0.73756

Document Title: Weight specifications	Function Group: 030	Information Type: Service Information	Date: 10/25/2025
Profile:			

Weight specifications

Basic machine with 600 mm track, incl. counterweight	19,000 kg (41,890 lb)
Counterweight	3,500 kg (7,720 lb)

Operating weights and ground pressure for complete excavator with:

5.2 m boom, 2.25 m dipper arm, 1,300 l bucket and 3,500 kg counterweight

Track width	Ground pressure	Total weight
600 mm	46.8 kPa (0.47 bar)	23.0 tonnes (50,700 lb)
700 mm	40.1 kPa (0.40 bar)	23.0 tonnes (50,700 lb)
900 mm	32.1 kPa (0.32 bar)	23.7 tonnes (52,240 lb)

Additional weights

Superstructure, incl. counterweight and diesel engine	10,400 kg (22,930 lb)
Diesel engine, incl. pump gearbox and pumps	980 kg (2,160 lb)

Document Title: Recommendations for hydraulic oil	Function Group: 160	Information Type: Service Information	Date: 10/25/2025
Profile:			

Recommendations for hydraulic oil

Type of oil	Viscosity	Ambient temperature	Compatibility	Remark
SHS 32	ISO VG 32 HR	-30 to +35 °C	Mixable with SHS 46	
SHS 46	ISO VG 46 HR	-15 to +50 °C	Mixable with SHS 32	
PANOLIN HLP SE SYNTH 46 [1]	Same as for mineral oil	-15 to +50 °C	Mixable with mineral oil but not other synthetic oils	Before changing from mineral oil to synthetic oil - contact Volvo
BP BIOHYD SE 46 [2]	Same as for mineral oil	-15 to +50 °C	Mixable with mineral oil but not other synthetic oils	Construction Equipment - Service

The machine is normally delivered with oil of typ the SHS 46.

[1](Biodegradable)

[2](Biodegradable)

Document Title: Dieseling in hydraulic cylinders	Function Group: 173	Information Type: Service Information	Date: 10/25/2025
Profile:			

Dieseling in hydraulic cylinders

If hydraulic oil mixed with air is compressed, the temperature rises and at a certain temperature some of the oil evaporates and ignites, thus so called dieseling takes place.

Dieseling causes burned piston seals and rings.

This problem is avoided if, after repairs, the lines to the hydraulic cylinders are vented in the following way. The hydraulic cylinders should be operated between end of stroke positions until the air is removed from the system. The load on the hydraulic system must be kept very low, while the air is being removed.

The dipper arm and bucket cylinders should be positioned so that any air will rise and gather at the outlet end of the cylinder. This means that the outlet end should be the highest point.

The piston should be at the opposite end of the cylinder. Wait a minute or so from the moment the cylinder is placed in this position, before you run the piston towards the outlet side.

Repeat this procedure several times (for instance three to five times).

Boom cylinders, which cannot be positioned as described above, must be run in and out about five times without any load in the bucket.

NOTE!

If the cylinders become pressurised through lifting the machine or lifting a load in the bucket before the air in the system has been removed, the seals will probably be damaged.

If a cylinder is to be pressure-tested after it has been repaired, the piston rod should be run in and out a few times, before the pressure is increased up to the test pressure.

Document Title: Filtering hydraulic oil	Function Group: 173	Information Type: Service Information	Date: 10/25/2025
Profile:			

Filtering hydraulic oil

Op nbr

[Filtering unit 14 031 832](#)

[Disposable filter: 14 025 665](#)

Filtering must be carried out in the following cases:

1. After major work on the hydraulic system for example work on the valve block, when changing tank and in cases of breakdown of a pump, hydraulic motor or a cylinder.
- After a test has proven that the oil is contaminated.
- On machines with re-occurring malfunctions of the hydraulic system.

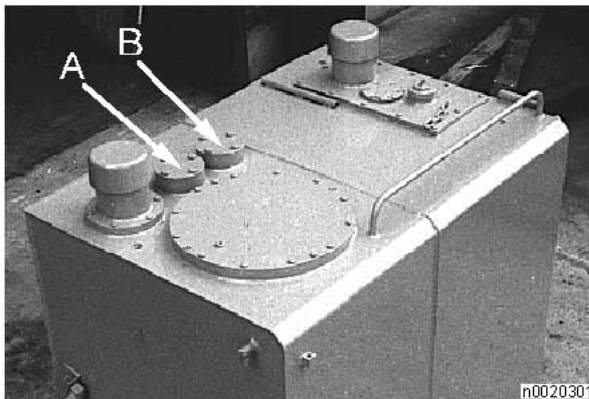

Figure 1

2. Secure the filtering unit to the hydraulic tank. The unit is secured with the bolts for the hydraulic tank filter cover.
3. Warm up the hydraulic oil to 35 °C if needed. Stop the diesel engine.
4. Remove the protective caps A and B from the top of the hydraulic tank.
5. Connect the suction line of the filtering unit to connection B and the return line to connection A, marked in the figure.
6. Start the filtering unit and run the hydraulic oil in the tank through the unit for approx. one hour.
7. Change the filter in the tank if the hydraulic oil was heavily contaminated.
8. Start the diesel engine and continue the filtering for a further two hours while operating the hydraulic functions of the machine. Make sure that all hydraulic functions are activated so that the oil in the entire system is filtered. Carry out the movements carefully so that the filtering unit is not dislocated from the tank.
9. Remove the filtering unit and re-fit the blind flanges to the tank.

After the filtering unit has been used, its filter container should be cleaned and a new disposable filter fitted.

Document Title: Instructions for shrinking	Function Group: 173	Information Type: Service Information	Date: 10/25/2025
Profile:			

Instructions for shrinking

1. **General**By "shrinkage fit" is meant that, at a certain temperature difference and a consequent change in measurements, a shaft and a hub can be assembled and become fixed when the temperature of the heated part drops and its size shrinks. Usually the shaft is kept at room temperature, or preferably below, whereas the hub is heated in different ways. This method used, for instance, when fitting a gear wheel to a shaft, is described below.
2. **Equipment**
 - a. Heating equipment
A gas burner with an adequate nozzle or an electric hot plate with an output of approx. 1500–2000 W, and a diameter of approx. 250 mm (10 in).
 - b. Measuring equipment
A shrinkage gauge Part.no. 14194288 for checking the correct measurement change in the hub.
3. **Heating**Prior to heating, make sure that the hub and shaft are free from burrs and defects that might otherwise impede the assembling of the parts.
 - a. **Hot plate**Heat the gear wheel on the plate until the shrinkage gauge can be easily pushed into the hub. Avoid exposing the measuring pin to heat or cold, as this will change its measurement. We recommend cooling the gauge to room temperature in between the times the gauge is used.
 - b. **Gas flame**Concentrate the heating to a circular area around the hub corresponding to about half of the gear wheel diameter, see Fig. 1. If the heat around the hub is to result in an increase in the diameter of the hole, some heat has to be added to the outer edge of the gear wheel. This has to be done with care so as not to damage the hardening of the gear teeth. Proceed with the heating of the gear wheel until the shrinkage gauge can be easily inserted in the hub.

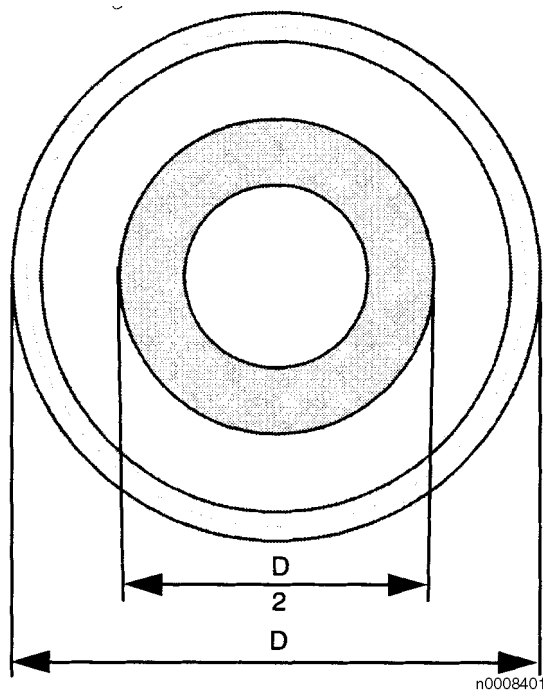

Figure 1

4. **Assembling**Once the assembling has been started, the parts should be assembled as quickly as possible, to avoid

heat from being transferred to the shaft, thus making assembling difficult or causing the parts to jam before they are correctly assembled. It is also important that the shaft is securely fixed in a vertical position in case the gear wheel should jam in an oblique position. With the shaft securely fixed it is easier to wriggle off the gear wheel quickly. If the gear wheel becomes fixed to the shaft before it is in its correct position, try to separate the wheel from the shaft as quickly as possible. If this is not possible, allow the parts to cool and proceed as described in the paragraph "Dismantling".

5. **Dismantling** Try to press the shaft out of the hub without heating the hub. If this fails, apply pressure to the shaft in a hydraulic press. Gradually heat the hub, while the parts are fitted in the press, until the shaft loosens. If the heat is transmitted into the shaft, the shaft diameter increases with the risk that the fit will become too tight, thus making dismantling impossible. If the parts tend to bind because of the heat being transmitted into the shaft, stop the operation and cool off the parts. Then make a new dismantling attempt.

Document Title: Instructions for vacuum pump	Function Group: 173	Information Type: Service Information	Date: 10/25/2025
Profile:			

Instructions for vacuum pump

Op nbr

[Vacuum pump: 14 190 806](#)

WARNING

When working on the hydraulic system of the machine, avoid contact with leaking hydraulic oil under pressure. Also avoid contact with hot hydraulic oil.

NOTE!

The diesel engine must never be running when the sealing boot is blocking the breather filter of the hydraulic tank as this might cause serious damage to the pump.

Fitting

1. Place the pump on the hydraulic oil tank.
2. Connect the plug to the 24 Volt socket on the machine and route the cable so that it will not be pinched anywhere.
3. Fit the sealing boot on the cap for the breather filter of the hydraulic tank and connect the hose from the pump to the sealing boot as shown [Invalid linktarget]
4. Start the pump with the switch and adjust the valve so that the partial vacuum **never** exceeds 300 millibar (8.86 in Hg).

NOTE!

If the partial vacuum exceeds 300 mb (8.86 in Hg), there is a risk that the gearbox oil may be sucked into the hydraulic system and that the hydraulic oil tank may be damaged.

Removing

5. Turn off the current for the pump with the switch.
6. Remove the hose from the sealing boot and then remove the sealing boot from the hydraulic oil tank cap.
7. Remove the plug from the 24 V socket on the machine.
8. Remove the pump.

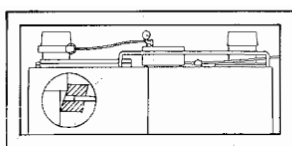

Figure 1

Document Title: Recommendations for cleanliness when working on hydraulic systems	Function Group: 173	Information Type: Service Information	Date: 10/25/2025
Profile:			

Recommendations for cleanliness when working on hydraulic systems



WARNING

When working on the hydraulic system of the machine, avoid contact with leaking hydraulic oil under pressure. Also avoid contact with hot hydraulic oil.

It is very important to keep the hydraulic system free from impurities, as these can cause abnormal wear and can lead to operation interruptions, which in turn means increased costs for service and repairs. In spite of the built-in filters in the system, the greatest cleanliness should be exercised when handling hydraulic components, oils and fluids.

NOTE!

The recommendations are grouped under the following headings:

The recommendations are grouped under the following headings:

1. Repairing hydraulic components in a workshop.
 2. Work on hydraulic system carried out in a workshop.
 3. Work carried out on hydraulic system on site.
 4. Storing and transporting hydraulic components.
 5. Storing and handling hydraulic oil.
1. **1. Repairing hydraulic components in a workshop**
 - Work on hydraulic components should be carried out separately from other workshop activities in a "so - called" clean room. The room should be well ventilated and the floor coated with an adherent (to dust) material. Machining, grinding etc must not be done in the "clean room".
 - The work place should be equipped with thoroughly cleaned tools and suitable vessel for cleaning of hydraulic components. Avoid the use of adjustable spanners and wrenches.
 - A vessel used for cleaning hydraulic components must not be used for cleaning anything else. The vessels should be cleaned often and new cleaning solution filled. The vessels should be equipped with a grating, to separate components from any sludge at the bottom.
 - Components handled in the "clean room" should always be prewashed first. Lye solutions or similar which cause rusting must not be used as a cleaning agent.
 - Work on the hydraulic system should always be planned so that it can be completed without delay.
 - When cleaning parts while repairing, dry and clean compressed air should be used for drying, not cotton waste or rags. A low-pressure nozzle should preferably be used.
 - When the repair of component has been completed, the components should always be plugged with clean plastic plugs of suitable size after which the component should be wrapped up.
 - When cleaning the "clean room" a cleaning method should be used which does not stir up the dust and dirt.
 - Hands and clothes should always be free from dirt.
 2. **2. Work on hydraulic system carried out in a workshop**
 - The machine should be cleaned before it is taken into the workshop.
 - The work place should be thoroughly tidied and the tools thoroughly cleaned and free from burrs.
 - The machine should be screened from other machines or work places where welding or grinding is carried out. Any place where the hydraulic system is opened should be thoroughly cleaned and protected with plastic sheeting.
 - The openings in components removed from the machine and those left open on the machine should be immediately plugged. The components should be placed in suitable containers wrapped in plastic

sheeting. No welding may be carried out on the machine because of fire hazard when the hydraulic system has been opened.

- The components removed from the machine, which are to be repaired, should be cleaned before they are taken into the "clean room".
- Oil drained from the machine should be filled into a vessel intended for waste oil and this oil should not normally be re-used.
- If the tank is to be emptied and the oil on visual inspection or testing is found to be free from discolouration and impurities, fill the oil into a clean vessel which is then sealed. Refilling of this oil or filling with new oil should always be done with the hand pump on the machine.
- When refitting a component, the part of the machine where it is to be fitted should be thoroughly cleaned and inspected. In cases of frequent breakdowns and highly contaminated oil and components, pipes, hoses and valves should be flushed through and blown clean.
- Hands and clothes should always be free from dirt.

3. **Work on hydraulic system carried out on site.**

- When necessary and if possible the machine should be moved to as dust-free an environment as possible. Or, as an alternative, the machine should be screened off with plastic sheeting or similar.
- A thorough trouble shooting should be carried out to eliminate unnecessary work. Test the movements of the hydraulic functions, check pressures and engine speed and listen. Adjustable spanners or wrenches should not be used when working on the hydraulic system. When the trouble has been traced, the place of approach should be cleaned and plastic sheeting placed so that it protects against dirt.
- Exchange components should be used to avoid repairs on site.
- Openings on components removed from the machine and all openings left open on the machine should be immediately plugged. Components removed from the machine should be wrapped in plastic sheeting and placed in suitable containers. Components which are to be re-fitted should be stored fitted with protective plugs and kept in plastic foil in plastic containers.
- Oil drained from the machine should be poured into vessels intended for waste oil and this oil should normally not be re-filled.
- If the tank is to be drained and the oil is found to be reusable, it should be drained into a clean vessel which is then sealed. Always use the hand pump on the machine when refilling oil or filling new oil.
- Always use a suitable cleaning solution which should be poured into a thoroughly clean vessel.
- Working clothes and hands should always be clean from dirt. If you have to climb onto the machine make sure your shoes are thoroughly clean.
- After each completed operation the tools should be thoroughly cleaned and deburred if needed.

4. **Storing and transporting hydraulic components**

- All hydraulic components should be stored in plastic bags or plastic sheeting and should be plugged. The wrapping should not be opened before the component is about to be used.
- Service vans should be fitted out and equipped in a way which facilitates order and cleanliness.
- Components which are too large to fit into the plastic containers should not be transported in the service vans but carried on a trailer instead.
- Each service van should carry a roll of plastic sheeting, plastic plugs of the most common sizes and types and plastic containers for components. Plugs and plastic sheeting should be of the disposable type.

5. **Storing and handling hydraulic oil**

- The hydraulic oil should be stored either in tanks or drums which can be sealed. The place where the oil is drained from the storage containers should not be near where machining or welding is carried out.
- All filling with oil should be done with the hand pump of the machine.
- Before filling, always check the new oil for contamination by water or other impurities. Carry out a visual check of the oil poured into a glass.
- A container used for transporting hydraulic oil should only be used for this purpose. The vessel should be marked and cleaned often.
- At the slightest suspicion of contamination, samples should be taken and sent away for analysis. Always clean the hydraulic oil immediately if the result of the analysis suggests this or if major work has been carried out on the hydraulic system.
- Only clean the tank if a layer of dirt has been deposited on the bottom of the tank. Otherwise flushing through is sufficient. The suction line should always be closed before cleaning is done by the use of a suitable cleaning agent.

Document Title: Description	Function Group: 210	Information Type: Service Information	Date: 10/25/2025
Profile:			

Description

TD61GE is a water cooled, direct injected, six cylinder, four stroke, turbocharged diesel engine.

The engine is equipped with an electric preheating coil in order to facilitate starting in cold weather. Standard equipment also includes a Fuel-Miser for automatic lowering of the engine speed when the operating controls are not activated.

Document Title: Specification, general	Function Group: 210	Information Type: Service Information	Date: 10/25/2025
Profile:			

Specification, general

Type	Volvo TD61GE
Output gross at 2100 rpm[1]	122 kW (166 hp)
Cylinder bore	98.43 mm (3,875 in)
Stroke	120 mm (4,724 in)
Displacement	5.48 litres (334 in ³)

Engine data				
Reg. No.	Engine type	Low idling speed rpm	High idling speed [2] rpm	Rated speed[3] rpm
4369-	TD61GE	600 +40/-20	2260 ±50	2100

[1](According to ISO 3046 / DIN 6270)

[2]Maximum speed when engine is not loaded.

[3]Nominal speed at max. stated output.

Document Title: Exchange of rubber cushion on the front engine mounting	Function Group: 218	Information Type: Service Information	Date: 10/25/2025
Profile:			

Exchange of rubber cushion on the front engine mounting

Op nbr

[E-tool: 14 290 231](#)

Disassembly

-  **WARNING**
Don't stick your hand into the place of the cushion. Don't leave the engine hanging. Place a cushion or a replacement for this between the parts of the attachment.
- Open up the engine hood and lock it.
- When changing the inner rubber cushion - remove the hatches between the engine and valve compartments.
- Get 2 bars of steel or wood that are strong enough to take the load with a good safety margin.
- Place the bars on top of the engine compartment over the front lifting attachment of the engine.
- Mount the E-tool (1) between the bars (2) and tighten the nut (3) slightly.

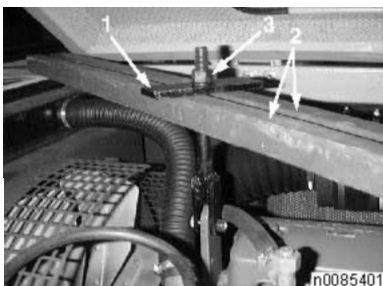

Figure 1

- Remove the screws (4) that holds the cushion (5).

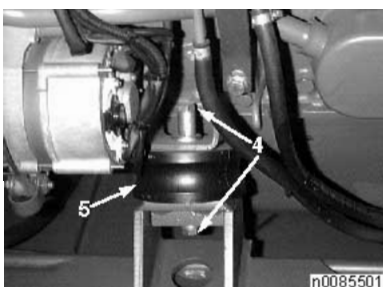

Figure 2

8. Lift the engine with the E-tool (by tightening the nut) much enough to set the cushion free.
9. Remove the cushion by using a suitable gripping tool.

Assembly

10. Place the new cushion in position by using a suitable gripping tool.
11. Centre the holes of the cushion to the attachment parts of the frame and the engine.
12. Screw in the screws (4) fully without tightening them.
13. Remove the E-tool.
14. Tighten the screws (4) to the prescribed torque (see torque table).

Document Title: Exchange of rubber cushion on the rear engine mounting	Function Group: 218	Information Type: Service Information	Date: 10/25/2025
Profile:			

Exchange of rubber cushion on the rear engine mounting

Op nbr

[E-tool: 14 290 231](#)

Disassembly

- 
WARNING
Don't stick your hand into the place of the cushion. Don't leave the engine hanging. Place a cushion or a replacement for this between the parts of the attachment.

Open up the engine hood and lock it.

- When changing the inner rubber cushion - remove the screws (6) and (8) and the hose retainers (7) and (9). Put the hoses aside.

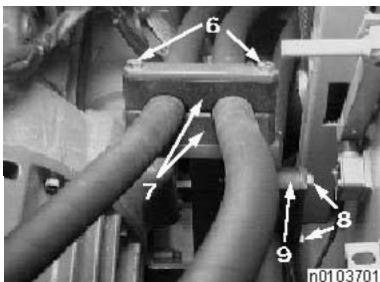

Figure 1

- Remove the screws (10). Remove the bracket from over the rubber cushion.

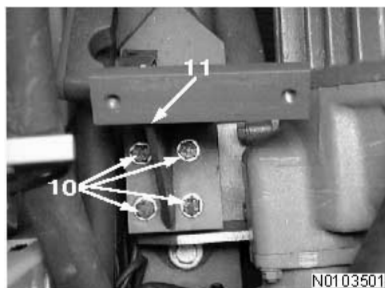

Figure 2

- Get 2 bars of steel or wood (2) that are strong enough to take the load with a good safety margin.



Figure 3

5. Place the bars on top of the engine compartment over the rear lifting attachment of the engine.
6. Mount the E-tool (1) between the bars (2) and tighten the nut (3) slightly.
7. Remove the screws (4) that holds the cushion.

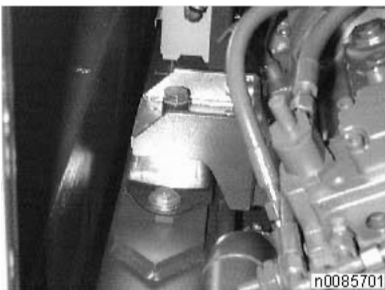

Figure 4

8. Lift the engine with the E-tool (by tightening the nut) much enough to set the cushion free.

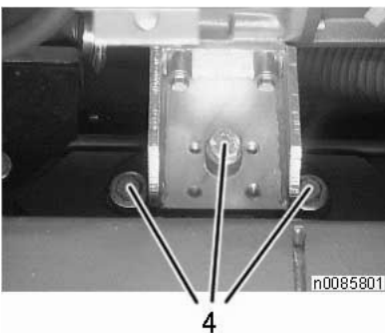

Figure 5

9. Remove the cushion by using a suitable gripping tool.

Assembly

10. Place the new cushion in position by using a suitable gripping tool.
11. Centre the holes of the cushion to the attachment parts of the frame and the engine.
12. Screw in the screws (4) fully without tightening them.

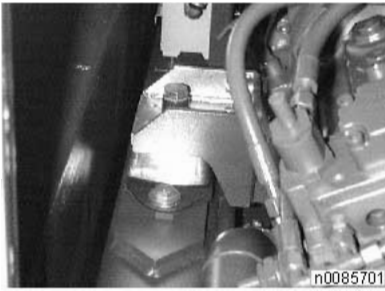

Figure 6

13. Remove the E-tool.
14. Tighten the screws (4) to the prescribed torque (see torque table).
15. Place the bracket (11) and tighten the screws (10) to the prescribed torque (see torque table).

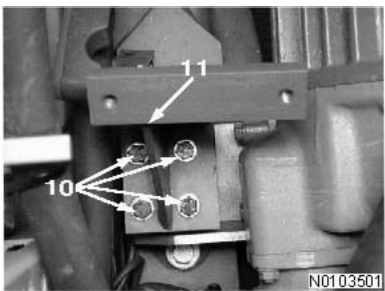

Figure 7

16. Place the hose retainers (7) and (9) and the hoses. Tighten the screws (6) and (8) to the prescribed torque (see torque table)

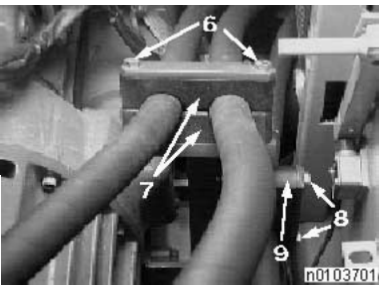

Figure 8

Document Title: Specification, capacities	Function Group: 220	Information Type: Service Information	Date: 10/25/2025
Profile:			

Specification, capacities

Diesel engine (lubricating oil)	22 litres (5.8 US gallons)
---------------------------------	----------------------------

Document Title: Repairing fuel filling pump	Function Group: 234	Information Type: Service Information	Date: 10/25/2025
Profile:			

Repairing fuel filling pump

Op nbr

[Vacuum pump 14190806.](#)

[Mandrel max ø32.](#)

Fault tracing and removing

1. **NOTE!**

THINK OF THE ENVIRONMENT - Collect any spilled diesel fuel in a vessel.

Loosen and pull out the hydraulic motor from the fuel filling pump. Start the diesel engine and check that the hydraulic motor works satisfactorily - if not, change it. When changing hydraulic motor, use a vacuum pump to avoid oil spillage.

Check the pump by turning the pump shaft with the aid of a screwdriver. If the shaft cannot be turned easily, disconnect the hoses and remove the pump for repair, as described below, or fit an exchange unit. The exchange unit consists of both pump and hydraulic motor.

Dismantling

2. Loosen the suction end of the pump and prize it loose with two screwdrivers. Remove the O-ring.
3. Tap the shaft into the pressure end of the pump until the key stops against the bushing. Prize out the impeller with the aid of two screwdrivers.
4. Remove the key and press the shaft out of the pressure end of the pump.
5. Drive out the spacer ring and the radial seal using a screwdriver and hammer.
6. Wash and check the parts. The most common fault is impurities which have stopped the impeller. Minor scores in the impeller can be removed by polishing with a fine emery cloth on a plane polishing block.

Assembling

7. Grease a new O-ring and radial seal. Position the O-ring in the groove in the suction end of the pump. Drive the radial seal into the pressure end using a mandrel. The sealing lip should be turned toward the impeller.
8. Secure the mandrel in a vice. In order to position the pump shaft correctly for the fitting of the key and the impeller, the mandrel should be secured so that 32 mm (1.26 in) protrudes above the jaws of the vice.
9. Insert the pump shaft in the pressure end of the pump and position the pump end on the mandrel secured in the vice.
10. Fit the key and impeller. The impeller should move easily on the key and the shaft otherwise there is a risk that the gear may run against one of the sides in the pressure end of the pump.
11. Fit the suction end and test with the aid of a screwdriver that the impeller turns easily.

Fitting

12. Re-fit the pump, fill it with diesel fuel and connect the hoses.
13. Position the cube in the shaft coupling and the ring on the hydraulic motor.
14. Secure the hydraulic motor to the fuel filling pump.
15. Remove the vacuum pump and test-run.

Document Title: Specification, capacities	Function Group: 234	Information Type: Service Information	Date: 10/25/2025
Profile:			

Specification, capacities

Fuel tank	340 litres (89.8 US gallons)
Hydraulically powered fuel filling pump, capacity, approx.	90 litres (23.8 US gallons) per minute

Product: Volvo EC230B Excavators Service Manual

Full Download: <https://www.arepairmanual.com/downloads/volvo-ec230b-excavators-service-manual/>

V O L V O

Service Information

Document Title: Specification, capacities	Function Group: 260	Information Type: Service Information	Date: 10/25/2025
Profile:			

Specification, capacities

Cooling system (incl. glycol)	32 litre (7.0 US gallon)
-------------------------------	--------------------------

Sample of manual. Download All 344 pages at:

<https://www.arepairmanual.com/downloads/volvo-ec230b-excavators-service-manual/>