

Product: 2006 Konica Minolta magicolor 7450 Service Repair Workshop Manual
Full Download: <https://www.arepairmanual.com/downloads/2006-konica-minolta-magicolor-7450-service-repair-workshop-manual/>

KONICA MINOLTA

SERVICE MANUAL

FIELD SERVICE

magicolor[®] 7450

Sample manual. Download All pages at:

<https://www.arepairmanual.com/downloads/2006-konica-minolta-magicolor-7450-se>

2006.05

KONICA MINOLTA BUSINESS TECHNOLOGIES, INC. Ver. 1.0

SAFETY AND IMPORTANT WARNINGS	S-1
IMPORTANT NOTICE	S-1
DESCRIPTION ITEMS FOR DANGER, WARNING AND CAUTION	S-1
SAFETY WARNINGS	S-2
WARNING INDICATIONS ON THE MACHINE	S-18
MEASURES TO TAKE IN CASE OF AN ACCIDENT	S-20
Composition of the service manual	C-1
Notation of the service manual	C-2

magicolor 7450 Main Unit

General	1
Maintenance	7
Adjustment/Setting	77
Troubleshooting	177
Appendix	241

Lower Feeder Unit

General	1
Maintenance	3
Adjustment/Setting	27
Troubleshooting	31

Duplex Option

General	1
Maintenance	3
Adjustment/Setting	7
Troubleshooting	9

Sample manual. Download All pages at:

<https://www.arepairmanual.com/downloads/2006-konica-minolta-magicolor-7450-se>

Blank Page

SAFETY AND IMPORTANT WARNING ITEMS

Read carefully the Safety and Important Warning Items described below to understand them before doing service work.

IMPORTANT NOTICE

Because of possible hazards to an inexperienced person servicing this product as well as the risk of damage to the product, KONICA MINOLTA BUSINESS TECHNOLOGIES, INC. (hereafter called the KMBT) strongly recommends that all servicing be performed only by KMBT-trained service technicians.



Changes may have been made to this product to improve its performance after this Service Manual was printed. Accordingly, KMBT does not warrant, either explicitly or implicitly, that the information contained in this Service Manual is complete and accurate.

The user of this Service Manual must assume all risks of personal injury and/or damage to the product while servicing the product for which this Service Manual is intended.



Therefore, this Service Manual must be carefully read before doing service work both in the course of technical training and even after that, for performing maintenance and control of the product properly.

Keep this Service Manual also for future service.













DESCRIPTION ITEMS FOR DANGER, WARNING AND CAUTION

In this Service Manual, each of three expressions “ DANGER”, “ WARNING”, and “ CAUTION” is defined as follows together with a symbol mark to be used in a limited meaning.

When servicing the product, the relevant works (disassembling, reassembling, adjustment, repair, maintenance, etc.) need to be conducted with utmost care.

-  **DANGER:** Action having a high possibility of suffering death or serious injury
-  **WARNING:** Action having a possibility of suffering death or serious injury
-  **CAUTION:** Action having a possibility of suffering a slight wound, medium trouble, and property damage

Symbols used for safety and important warning items are defined as follows:

 :Precaution when servicing the product.	 General precaution	 Electric hazard	 High temperature
 :Prohibition when servicing the product.	 General prohibition	 Do not touch with wet hand	 Do not disassemble
 :Direction when servicing the product.	 General instruction	 Unplug	 Ground/Earth

SAFETY WARNINGS

[1] MODIFICATIONS NOT AUTHORIZED BY KONICA MINOLTA BUSINESS TECHNOLOGIES, INC.

KONICA MINOLTA brand products are renowned for their high reliability. This reliability is achieved through high-quality design and a solid service network.

Product design is a highly complicated and delicate process where numerous mechanical, physical, and electrical aspects have to be taken into consideration, with the aim of arriving at proper tolerances and safety factors. For this reason, unauthorized modifications involve a high risk of degradation in performance and safety. Such modifications are therefore strictly prohibited. The points listed below are not exhaustive, but they illustrate the reasoning behind this policy.

Prohibited Actions

⚠ DANGER

- Using any cables or power cord not specified by KMBT.



- Using any fuse or thermostat not specified by KMBT. Safety will not be assured, leading to a risk of fire and injury.

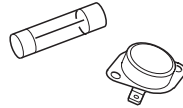

- Disabling fuse functions or bridging fuse terminals with wire, metal clips, solder or similar object.

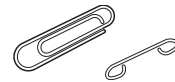

- Disabling relay functions (such as wedging paper between relay contacts)

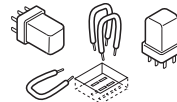

- Disabling safety functions (interlocks, safety circuits, etc.) Safety will not be assured, leading to a risk of fire and injury.

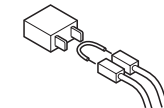

- Making any modification to the product unless instructed by KMBT



- Using parts not specified by KMBT

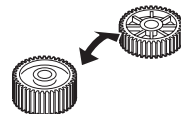

[2] POWER PLUG SELECTION

In some countries or areas, the power plug provided with the product may not fit wall outlet used in the area. In that case, it is obligation of customer engineer (hereafter called the CE) to attach appropriate power plug or power cord set in order to connect the product to the supply.

Power Cord Set or Power Plug

WARNING

- Use power supply cord set which meets the following criteria:
 - provided with a plug having configuration intended for the connection to wall outlet appropriate for the product's rated voltage and current, and
 - the plug has pin/terminal(s) for grounding, and
 - provided with three-conductor cable having enough current capacity, and
 - the cord set meets regulatory requirements for the area.

Use of inadequate cord set leads to fire or electric shock.



- Attach power plug which meets the following criteria:
 - having configuration intended for the connection to wall outlet appropriate for the product's rated voltage and current, and
 - the plug has pin/terminal(s) for grounding, and
 - meets regulatory requirements for the area.

Use of inadequate cord set leads to the product connecting to inadequate power supply (voltage, current capacity, grounding), and may result in fire or electric shock.



- Conductors in the power cable must be connected to terminals of the plug according to the following order:
 - Black or Brown: L (line)
 - White or Light Blue: N (neutral)
 - Green/Yellow: PE (earth)

Wrong connection may cancel safeguards within the product, and results in fire or electric shock.



[3] CHECKPOINTS WHEN PERFORMING ON-SITE SERVICE

KONICA MINOLTA brand products are extensively tested before shipping, to ensure that all applicable safety standards are met, in order to protect the customer and customer engineer (hereafter called the CE) from the risk of injury. However, in daily use, any electrical equipment may be subject to parts wear and eventual failure. In order to maintain safety and reliability, the CE must perform regular safety checks.

1. Power Supply

⚠ WARNING	
<ul style="list-style-type: none"> • Check that mains voltage is as specified. Connection to wrong voltage supply may result in fire or electric shock. 	
<ul style="list-style-type: none"> • Connect power plug directly into wall outlet having same configuration as the plug. Use of an adapter leads to the product connecting to inadequate power supply (voltage, current capacity, grounding), and may result in fire or electric shock. If proper wall outlet is not available, advice the customer to contact qualified electrician for the installation. 	
<ul style="list-style-type: none"> • Plug the power cord into the dedicated wall outlet with a capacity greater than the maximum power consumption. If excessive current flows in the wall outlet, fire may result. 	
<ul style="list-style-type: none"> • If two or more power cords can be plugged into the wall outlet, the total load must not exceed the rating of the wall outlet. If excessive current flows in the wall outlet, fire may result. 	
<ul style="list-style-type: none"> • Make sure the power cord is plugged in the wall outlet securely. Contact problems may lead to increased resistance, overheating, and the risk of fire. 	
<ul style="list-style-type: none"> • Check whether the product is grounded properly. If current leakage occurs in an ungrounded product, you may suffer electric shock while operating the product. Connect power plug to grounded wall outlet. 	

Power Plug and Cord

WARNING

- When using the power cord set (inlet type) that came with this product, make sure the connector is securely inserted in the inlet of the product.

When securing measure is provided, secure the cord with the fixture properly.

If the power cord (inlet type) is not connected to the product securely, a contact problem may lead to increased resistance, overheating, and risk of fire.

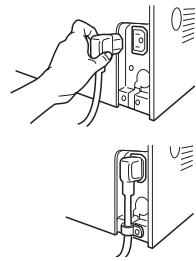

- Check whether the power cord is not stepped on or pinched by a table and so on.

Overheating may occur there, leading to a risk of fire.

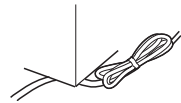

- Check whether the power cord is damaged. Check whether the sheath is damaged.

If the power plug, cord, or sheath is damaged, replace with a new power cord (with plug and connector on each end) specified by KMBT. Using the damaged power cord may result in fire or electric shock.

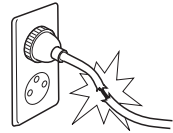

- Do not bundle or tie the power cord.

Overheating may occur there, leading to a risk of fire.

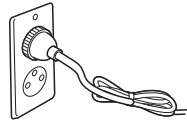

- Check whether dust is collected around the power plug and wall outlet.

Using the power plug and wall outlet without removing dust may result in fire.

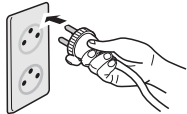

- Do not insert the power plug into the wall outlet with a wet hand.

The risk of electric shock exists.



- When unplugging the power cord, grasp the plug, not the cable.

The cable may be broken, leading to a risk of fire and electric shock.

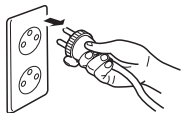

Wiring

WARNING

- Never use multi-plug adapters to plug multiple power cords in the same outlet.

If used, the risk of fire exists.

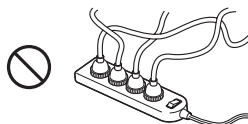

- When an extension cord is required, use a specified one. Current that can flow in the extension cord is limited, so using a too long extension cord may result in fire.

Do not use an extension cable reel with the cable taken up. Fire may result.



2. Installation Requirements

Prohibited Installation Places

WARNING

- Do not place the product near flammable materials or volatile materials that may catch fire.

A risk of fire exists.



- Do not place the product in a place exposed to water such as rain.

A risk of fire and electric shock exists.

When not Using the Product for a long time

WARNING

- When the product is not used over an extended period of time (holidays, etc.), switch it off and unplug the power cord.

Dust collected around the power plug and outlet may cause fire.

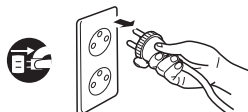

Ventilation

⚠ CAUTION

- The product generates ozone gas during operation, but it will not be harmful to the human body.

If a bad smell of ozone is present in the following cases, ventilate the room.

- a. When the product is used in a poorly ventilated room
- b. When taking a lot of copies
- c. When using multiple products at the same time



Stability

⚠ CAUTION

- Be sure to lock the caster stoppers.

In the case of an earthquake and so on, the product may slide, leading to a injury.



Inspection before Servicing

⚠ CAUTION

- Before conducting an inspection, read all relevant documentation (service manual, technical notices, etc.) and proceed with the inspection following the prescribed procedure, using only the prescribed tools. Do not make any adjustment not described in the documentation.

If the prescribed procedure or tool is not used, the product may break and a risk of injury or fire exists.

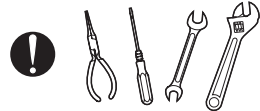

- Before conducting an inspection, be sure to disconnect the power plugs from the product and options.

When the power plug is inserted in the wall outlet, some units are still powered even if the POWER switch is turned OFF. A risk of electric shock exists.

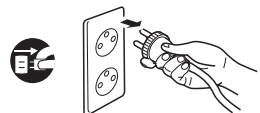

- The area around the fixing unit is hot.

You may get burnt.

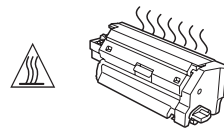

Work Performed with the Product Powered On

WARNING

- Take every care when making adjustments or performing an operation check with the product powered.

If you make adjustments or perform an operation check with the external cover detached, you may touch live or high-voltage parts or you may be caught in moving gears or the timing belt, leading to a risk of injury.



- Take every care when servicing with the external cover detached.

High-voltage exists around the drum unit. A risk of electric shock exists.



Safety Checkpoints

WARNING

- Check the exterior and frame for edges, burrs, and other damage.

The user or CE may be injured.



- Do not allow any metal parts such as clips, staples, and screws to fall into the product.

They can short internal circuits and cause electric shock or fire.

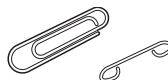

- Check wiring for squeezing and any other damage.

Current can leak, leading to a risk of electric shock or fire.



- Carefully remove all toner remnants and dust from electrical parts and electrode units such as a charging corona unit.

Current can leak, leading to a risk of product trouble or fire.



- Check high-voltage cables and sheaths for any damage.

Current can leak, leading to a risk of electric shock or fire.



Safety Checkpoints

WARNING

- Check electrode units such as a charging corona unit for deterioration and sign of leakage.

Current can leak, leading to a risk of trouble or fire.



- Before disassembling or adjusting the write unit (P/H unit) incorporating a laser, make sure that the power cord has been disconnected.

The laser light can enter your eye, leading to a risk of loss of eyesight.



- Do not remove the cover of the write unit. Do not supply power with the write unit shifted from the specified mounting position.

The laser light can enter your eye, leading to a risk of loss of eyesight.



- When replacing a lithium battery, replace it with a new lithium battery specified in the Parts Guide Manual. Dispose of the used lithium battery using the method specified by local authority.

Improper replacement can cause explosion.



- After replacing a part to which AC voltage is applied (e.g., optical lamp and fixing lamp), be sure to check the installation state.

A risk of fire exists.

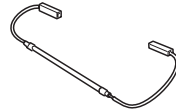

- Check the interlock switch and actuator for loosening and check whether the interlock functions properly.

If the interlock does not function, you may receive an electric shock or be injured when you insert your hand in the product (e.g., for clearing paper jam).

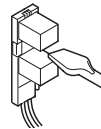

- Make sure the wiring cannot come into contact with sharp edges, burrs, or other pointed parts.

Current can leak, leading to a risk of electric shock or fire.



Safety Checkpoints

WARNING

- Make sure that all screws, components, wiring, connectors, etc. that were removed for safety check and maintenance have been reinstalled in the original location. (Pay special attention to forgotten connectors, pinched cables, forgotten screws, etc.)



A risk of product trouble, electric shock, and fire exists.

Handling of Consumables

WARNING

- Toner and developer are not harmful substances, but care must be taken not to breathe excessive amounts or let the substances come into contact with eyes, etc. It may be stimulative.

If the substances get in the eye, rinse with plenty of water immediately. When symptoms are noticeable, consult a physician.



- Never throw the used cartridge and toner into fire. You may be burned due to dust explosion.



Handling of Service Materials

CAUTION

- Unplug the power cord from the wall outlet. Drum cleaner (isopropyl alcohol) and roller cleaner (acetone-based) are highly flammable and must be handled with care. A risk of fire exists.

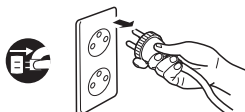

- Do not replace the cover or turn the product ON before any solvent remnants on the cleaned parts have fully evaporated.

A risk of fire exists.



Handling of Service Materials

CAUTION

- Use only a small amount of cleaner at a time and take care not to spill any liquid. If this happens, immediately wipe it off.

A risk of fire exists.



- When using any solvent, ventilate the room well.
Breathing large quantities of organic solvents can lead to discomfort.

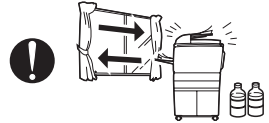

[4] Used Batteries Precautions

ALL Areas

CAUTION

Danger of explosion if battery is incorrectly replaced.

Replace only with the same or equivalent type recommended by the manufacturer.

Dispose of used batteries according to the manufacturer's instructions.

Germany

VORSICHT!

Explosionsgefahr bei unsachgemäßem Austausch der Batterie.

Ersatz nur durch denselben oder einen vom Hersteller empfohlenen gleichwertigen Typ.

Entsorgung gebrauchter Batterien nach Angaben des Herstellers.

France

ATTENTION

Il y a danger d'explosion s'il y a remplacement incorrect de la batterie.

Remplacer uniquement avec une batterie du même type ou d'un type équivalent recommandé par le constructeur.

Mettre au rebut les batteries usagées conformément aux instructions du fabricant.

Denmark

ADVARSEL!

Lithiumbatteri - Eksplosionsfare ved fejlagtig håndtering.

Udskiftning må kun ske med batteri af samme fabrikat og type.

Levér det brugte batteri tilbage til leverandøren.

Finland, Sweden

VAROITUS

Paristo voi räjähtää, jos se on virheellisesti asennettu.

Vaihda paristo ainoastaan laitevalmistajan suosittelemaan tyyppiin.

Hävittä käytetty paristo valmistajan ohjeiden mukaisesti.

VARNING

Explosionsfara vid felaktigt batteribyte.

Använd samma batterityp eller en ekvivalent typ som rekommenderas av apparattillverkaren.

Kassera använt batteri enligt fabrikantens instruktion.

Norway

ADVARSEL

Eksplosjonsfare ved feilaktig skifte av batteri.

Benytt samme batteritype eller en tilsvarende type anbefalt av apparatfabrikanten.

Brukte batterier kasseres i henhold til fabrikantens instruksjoner.

[5] FUSE

CAUTION
Double pole / neutral fusing

ATTENTION
Double pôle / fusible sur le neutre.

[6] Laser Safety

- This is a digital machine certified as a Class 1 laser product. There is no possibility of danger from a laser, provided the machine is serviced according to the instruction in this manual.

6.1 Internal Laser Radiation

semiconductor laser	
Maximum power of the laser diode	10 mW
Maximum average radiation power (*)	8.0 μ W
Wavelength	775-800 nm

*at laser aperture of the Print Head Unit

- This product employs a Class 3B laser diode that emits an invisible laser beam. The laser diode and the scanning polygon mirror are incorporated in the print head unit.
- The print head unit is NOT A FIELD SERVICEABLE ITEM. Therefore, the print head unit should not be opened under any circumstances.

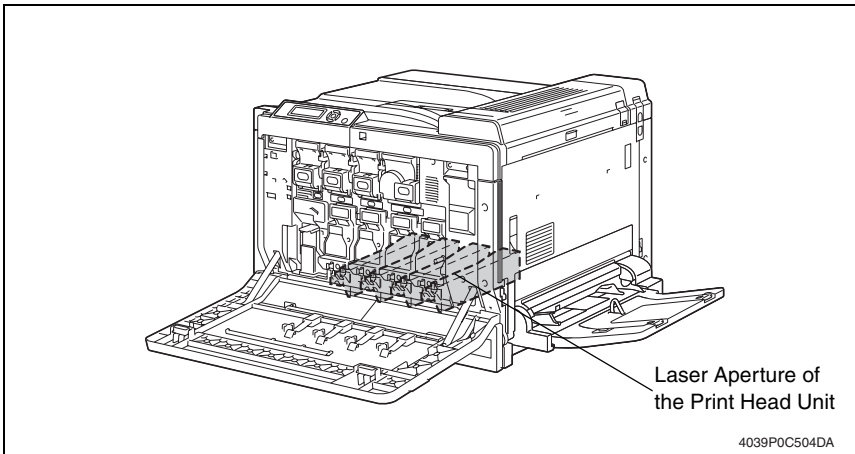

**U.S.A., Canada
(CDRH Regulation)**

- This machine is certified as a Class 1 Laser product under Radiation Performance Standard according to the Food, Drug and Cosmetic Act of 1990. Compliance is mandatory for Laser products marketed in the United States and is reported to the Center for Devices and Radiological Health (CDRH) of the U.S. Food and Drug Administration of the U.S. Department of Health and Human Services (DHHS). This means that the device does not produce hazardous laser radiation.
- The label shown on page S-16 indicates compliance with the CDRH regulations and must be attached to laser products marketed in the United States.

CAUTION

- **Use of controls, adjustments or performance of procedures other than those specified in this manual may result in hazardous radiation exposure.**

semiconductor laser	
Maximum power of the laser diode	10 mW
Wavelength	775-800 nm

All Areas

CAUTION

- **Use of controls, adjustments or performance of procedures other than those specified in this manual may result in hazardous radiation exposure.**

semiconductor laser	
Maximum power of the laser diode	10 mW
Wavelength	775-800 nm

Denmark

ADVARSEL

- **Usynlig laserstråling ved åbning, når sikkerhedsafbrydere er ude af funktion. Undgå udsættelse for stråling. Klasse 1 laser produkt der opfylder IEC60825-1 sikkerheds kravene.**

halvlederlaser	
Laserdiodens højeste styrke	10 mW
bølgelængden	775-800 nm

Finland, Sweden

LUOKAN 1 LASERLAITE
KLASS 1 LASER APPARAT
VAROITUS!

- Laitteen käyttäminen muulla kuin tässä käyttöohjeessa mainitulla tavalla saattaa altistaa käyttäjän turvallisuusluokan 1 ylittävälle näkymättömälle laser-säteilylle.

puolijohdelaser	
Laserdiodin suurin teho	10 mW
aallonpituus	775-800 nm

WARNING!

- Om apparaten används på annat sätt än i denna bruksanvisning specificerats, kan användaren utsättas för osynlig laserstrålning, som överskrider gränsen för laserklass 1.

halvledarlasert	
Den maximala effekten för laserdioden	10 mW
våglängden	775-800 nm

VARO!

- Avattaessa ja suojalukitus ohitettaessa olet alttiina näkymättömälle laser-säteilylle. Älä katso säteeseen.

WARNING!

- Osynlig laserstrålning när denna del är öppnad och spärren är urkopplad. Betrakta ej strålen.

Norway

ADVERSEL

- Dersom apparatet brukes på annen måte enn spesifisert i denne bruksanvisning, kan brukeren utsettes for usynlig laserstrålning, som overskrider grensen for laser klass 1.

halvleder laser	
Maksimal effekt till laserdioder	10 mW
bølgelengde	775-800 nm

6.2 Laser Safety Label

- A laser safety label is attached to the inside of the machine as shown below.

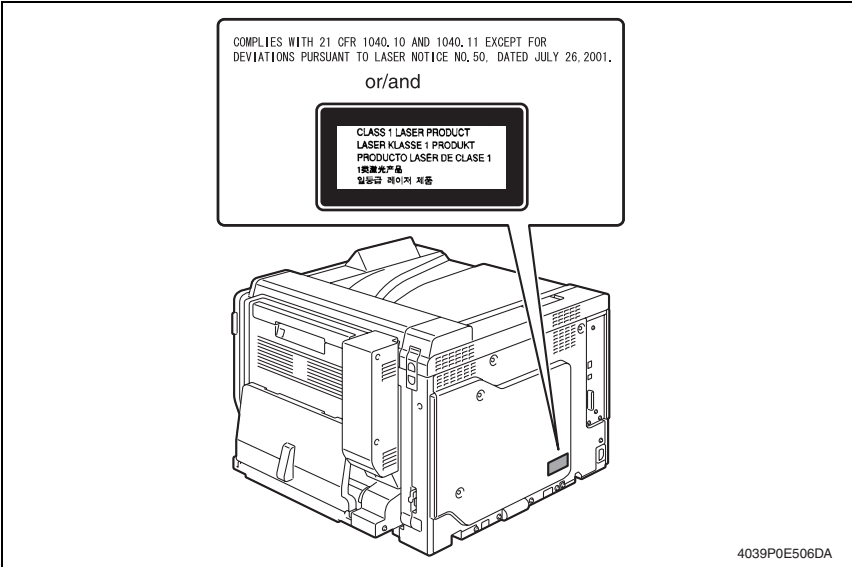

6.3 Laser Caution Label

- A laser caution label is attached to the outside of the machine as shown below.

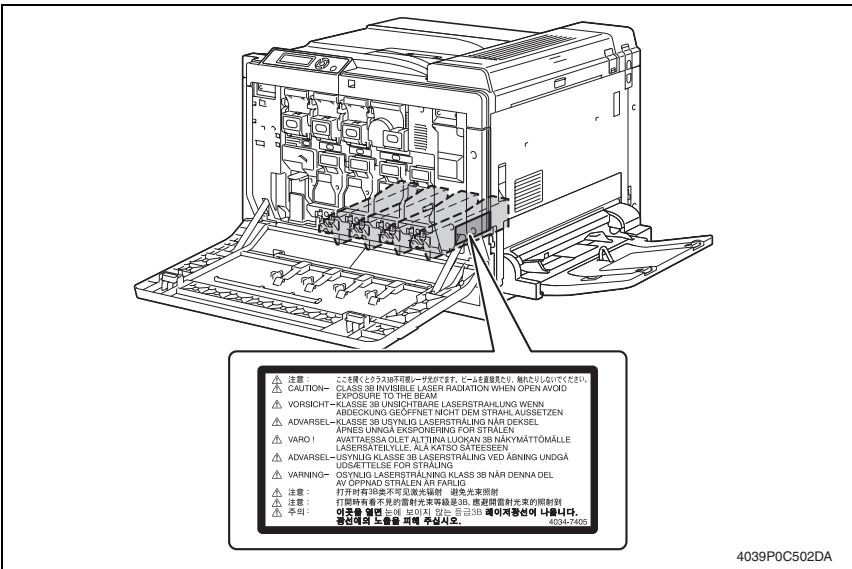

6.4 PRECAUTIONS FOR HANDLING THE LASER EQUIPMENT

- When laser protective goggles are to be used, select ones with a lens conforming to the above specifications.
- When a disassembly job needs to be performed in the laser beam path, such as when working around the printerhead and PC Drum, be sure first to turn the printer OFF.
- If the job requires that the printer be left ON, take off your watch and ring and wear laser protective goggles.
- A highly reflective tool can be dangerous if it is brought into the laser beam path. Use utmost care when handling tools on the user's premises.
- The Print Head is not to be disassembled or adjusted in the field. Replace the Unit or Assembly including the Control Board. Therefore, remove the Laser Diode, and do not perform Control Board trimmer adjustment.

WARNING INDICATIONS ON THE MACHINE

Caution labels shown are attached in some areas on/in the machine.
When accessing these areas for maintenance, repair, or adjustment, special care should be taken to avoid burns and electric shock.

 **High voltage**

- This area generates high voltage. Be careful not to touch here when the power is turned ON to avoid getting an electric shock.

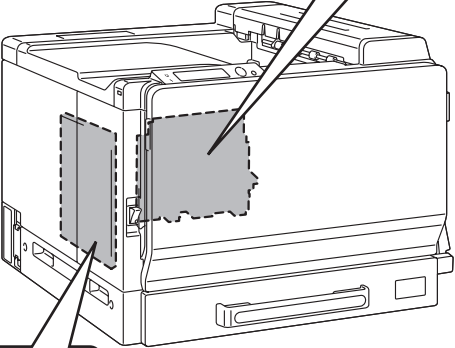
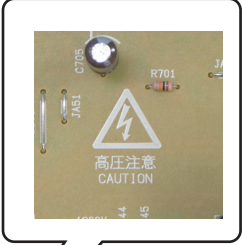

 **High voltage**

- This area generates high voltage. Be careful not to touch here when the power is turned ON to avoid getting an electric shock.

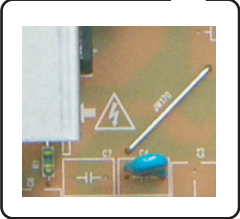

4039POC505DA



WARNING

- Do not position the used Waste Toner Box so that it is standing on end or tilted, otherwise toner may spill.



WARNING

- Do not burn used Toner Cartridges. Toner expelled from the fire is dangerous.

⚠ WARNING	⚠ ATTENTION	⚠ انتذار	
⚠ WARNING	⚠ 警告		
⚠ ATENCIÓN	⚠ 경고		
⚠ AVVISO	⚠ AVISO		

TONER	⚠ WARNING	⚠ ATTENTION	
	⚠ WARNING	⚠ 警告	
	⚠ ATENCIÓN	⚠ 경고	
	⚠ AVVISO	⚠ انتذار	
BLACK / SCHWARZ NOIR / ブラック	⚠ AVISO		
Net Wt. 43g(1.51oz)	⚠ AVISO		
	⚠ AVISO		
		Toner made in Japan / Assembled in China	86029701

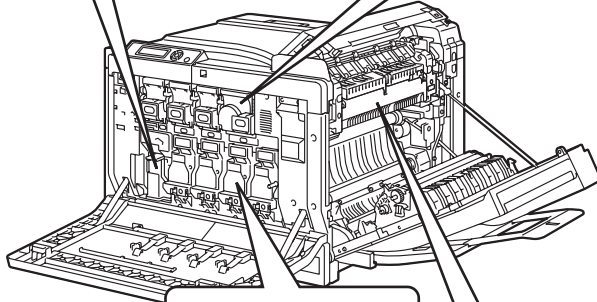

WARNING

- Do not burn used Imaging Units. Toner expelled from the fire is dangerous.

	⚠ WARNING	⚠ ATTENTION
	⚠ WARNING	⚠ 警告
	⚠ ATENCIÓN	⚠ 경고
	⚠ AVVISO	⚠ انتذار
	⚠ AVISO	

	CAUTION High Temperature!	ATTENTION Température élevée!	CUIDADO Alta temperatura!	注意 高温!
	VORSICHT Heiße Oberfläche!	PRECAUCIÓN ¡Temperatura alta!	ATTENZIONE Alta temperatura!	注意 高温! تحذير حرارة عالية!



CAUTION

- The area around the Fusing Unit is extremely hot. Touching any part other than those indicated may result in burns.

4039POC501DA



CAUTION:

- You may be burned or injured if you touch any area that you are advised not to touch by any caution label. Do not remove caution labels. If any caution label has come off or soiled and therefore the caution cannot be read, contact our Service Office.

MEASURES TO TAKE IN CASE OF AN ACCIDENT

1. If an accident has occurred, the distributor who has been notified first must immediately take emergency measures to provide relief to affected persons and to prevent further damage.
2. If a report of a serious accident has been received from a customer, an on-site evaluation must be carried out quickly and KMBT must be notified.
3. To determine the cause of the accident, conditions and materials must be recorded through direct on-site checks, in accordance with instructions issued by KMBT.
4. For reports and measures concerning serious accidents, follow the regulations specified by every distributor.

Composition of the service manual

This service manual consists of Theory of Operation section and Field Service section to explain the main machine and its corresponding options.

Theory of Operation section gives, as information for the CE to get a full understanding of the product, a rough outline of the object and role of each function, the relationship between the electrical system and the mechanical system, and the timing of operation of each part.

Field Service section gives, as information required by the CE at the site (or at the customer's premise), a rough outline of the service schedule and its details, maintenance steps, the object and role of each adjustment, error codes and supplementary information.

The basic configuration of each section is as follows. However some options may not be applied to the following configuration.

<Theory of Operation section>

OUTLINE:	Explanation of system configuration, product specifications, unit configuration, and paper path
COMPOSITION/OPERATION:	Explanation of configuration of each unit, operating system, and control system

<Field Service section>

GENERAL:	Explanation of system configuration, and product specifications
MAINTENANCE:	Explanation of service schedule, maintenance steps, service tools, removal/reinstallation methods of major parts, and firmware version up method etc.
ADJUSTMENT/SETTING:	Explanation of utility mode, service mode, and mechanical adjustment etc.
TROUBLESHOOTING:	Explanation of lists of jam codes and error codes, and their countermeasures etc.
APPENDIX:	Parts layout drawings, connector layout drawings, timing chart, overall layout drawing are attached.

Notation of the service manual

A. Product name

In this manual, each of the products is described as follows:

- | | |
|---------------------------|------------------------------|
| (1) PWB-P: | Controller Board |
| (2) magicolor 7450: | Main unit |
| (3) Microsoft Windows 95: | Windows 95 |
| Microsoft Windows 98: | Windows 98 |
| Microsoft Windows Me: | Windows Me |
| Microsoft Windows NT 4.0: | Windows NT 4.0 or Windows NT |
| Microsoft Windows 2000: | Windows 2000 |
| Microsoft Windows XP: | Windows XP |

When the description is made in combination of the OS's mentioned above:

- Windows 95/98/Me
- Windows NT 4.0/2000
- Windows NT/2000/XP
- Windows 95/98/Me/ NT/2000/XP

B. Brand name

The company names and product names mentioned in this manual are the brand name or the registered trademark of each company.



KONICA MINOLTA

SERVICE MANUAL

FIELD SERVICE

magicolor[®] 7450

Main Unit





Revision history

After publication of this service manual, the parts and mechanism may be subject to change for improvement of their performance.

Therefore, the descriptions given in this service manual may not coincide with the actual machine.

When any change has been made to the descriptions in the service manual, a revised version will be issued with a revision mark added as required.

Revision mark:

- To indicate clearly a section revised, show  to the left of the revised section.
A number within  represents the number of times the revision has been made.
- To indicate clearly a section revised, show  in the lower outside section of the corresponding page.
A number within  represents the number of times the revision has been made.

NOTE

Revision marks shown in a page are restricted only to the latest ones with the old ones deleted.

- When a page revised in Ver. 2.0 has been changed in Ver. 3.0:
The revision marks for Ver. 3.0 only are shown with those for Ver. 2.0 deleted.
- When a page revised in Ver. 2.0 has not been changed in Ver. 3.0:
The revision marks for Ver. 2.0 are left as they are.

2006/05	1.0	—	Issue of the first edition
Date	Service manual Ver.	Revision mark	Descriptions of revision

CONTENTS

magicolor 7450 Main Unit

General

1.	System configuration.....	1
2.	Product specifications	2

Maintenance

3.	Periodical check	7
3.1	Maintenance items.....	7
3.1.1	Parts to be replaced by users (CRU)	7
3.1.2	Periodical parts replacement 1 (per 120,000-print).....	7
3.1.3	Periodical parts replacement 2 (per 200,000-print).....	8
3.1.4	Periodical parts replacement 3 (per 300,000-print).....	8
3.2	Maintenance parts.....	9
3.2.1	Replacement parts.....	9
3.3	Concept of parts life.....	11
3.4	Maintenance procedure (Periodical check parts)	13
3.4.1	Replacing the Tray 2 Feed Roller (Standard).....	13
3.4.2	Replacing the Tray 2 Separation Roller.....	13
3.4.3	Replacing the Tray 1 Feed Roller (Bypass).....	14
3.4.4	Replacing the Tray 1 Separation Roller.....	16
3.4.5	Replacing the Waste Toner Bottle	17
3.4.6	Replacing the Ozone Filter.....	18
3.4.7	Replacing the Deodorant Filter	18
3.4.8	Replacing the Dust Filter/Vertical Conveyance	18
3.4.9	Replacing the Dust Filter/Cooling Fan	19
3.5	Replacing the unit.....	19
3.5.1	Replacing the Transfer Roller.....	19
3.5.2	Replacing the Transfer Belt	20
3.5.3	Replacing the Toner Cartridge (C, M, Y, K).....	22
3.5.4	Replacing the Imaging Unit (C, M, Y, K).....	23
3.5.5	Replacing the Fusing Unit.....	26
4.	Service tool	28
4.1	CE Tool list.....	28
4.2	Print materials.....	29
4.2.1	Imaging Unit Single Parts (IU)	29

4.2.2	Toner Cartridge Single Parts (T/C)	29
4.2.3	Waste Toner Bottle	29
4.2.4	Maintenance Kit	29
5.	Firmware upgrade	30
5.1	Firmware rewriting	30
5.1.1	Upgrade procedure	30
6.	Other	35
6.1	Disassembly/Adjustment prohibited items	35
6.2	Disassembly/Assembly/Cleaning list (Other parts)	36
6.2.1	Disassembly/Assembly parts list	36
6.2.2	Cleaning parts list	37
6.3	Disassembly/Assembly procedure	38
6.3.1	Rear Left Cover/Front Left Cover/Upper Front Cover	38
6.3.2	Rear Right Cover/Rear Cover	38
6.3.3	Tray 1 Left Cover /Tray 1 Right Cover /Tray 1 Upper Cover	39
6.3.4	Front Door	39
6.3.5	Exit Tray	40
6.3.6	Control Panel	41
6.3.7	Tray 2	42
6.3.8	Front Cover	44
6.3.9	Controller Board (PWB-P)	46
6.3.10	Memory (DIMM0)	47
6.3.11	Hard Disk Kit (Option)	48
6.3.12	Mechanical Control Board (PWB-M)	48
6.3.13	RTC Board (PWB-R)	51
6.3.14	DC Power Supply (PU1)	51
6.3.15	High Voltage Unit (HV1)	53
6.3.16	Tray 2 Paper Size Board (PWB-I)	54
6.3.17	PH Interface Board (PWB-D)	55
6.3.18	Multi Bypass Unit	57
6.3.19	PH Unit	58
6.3.20	Transport Drive Assy	62
6.3.21	Hopper Drive Assy	64
6.3.22	Right Door Assy	65
6.3.23	Cooling Fan Motor/2 (M22) Assy	67
6.3.24	Color Developing Motor (M3)	68
6.3.25	Color PC Drum Motor (M2)	68
6.3.26	Toner Supply Motor C/K (M7)	68

