

8. DRIVE AND DRIVEN PULLEYS/ V-BELT

DRIVE AND DRIVEN PULLEYS/V-BELT

SCHEMATIC DRAWING-----	8- 1
SERVICE INFORMATION-----	8- 2
TROUBLESHOOTING -----	8- 2
LEFT CRANKCASE COVER -----	8- 3
DRIVE PULLEY -----	8- 4
CLUTCH OUTER/DRIVEN PULLEY/V-BELT -----	8- 4



SCHEMATIC DRAWING

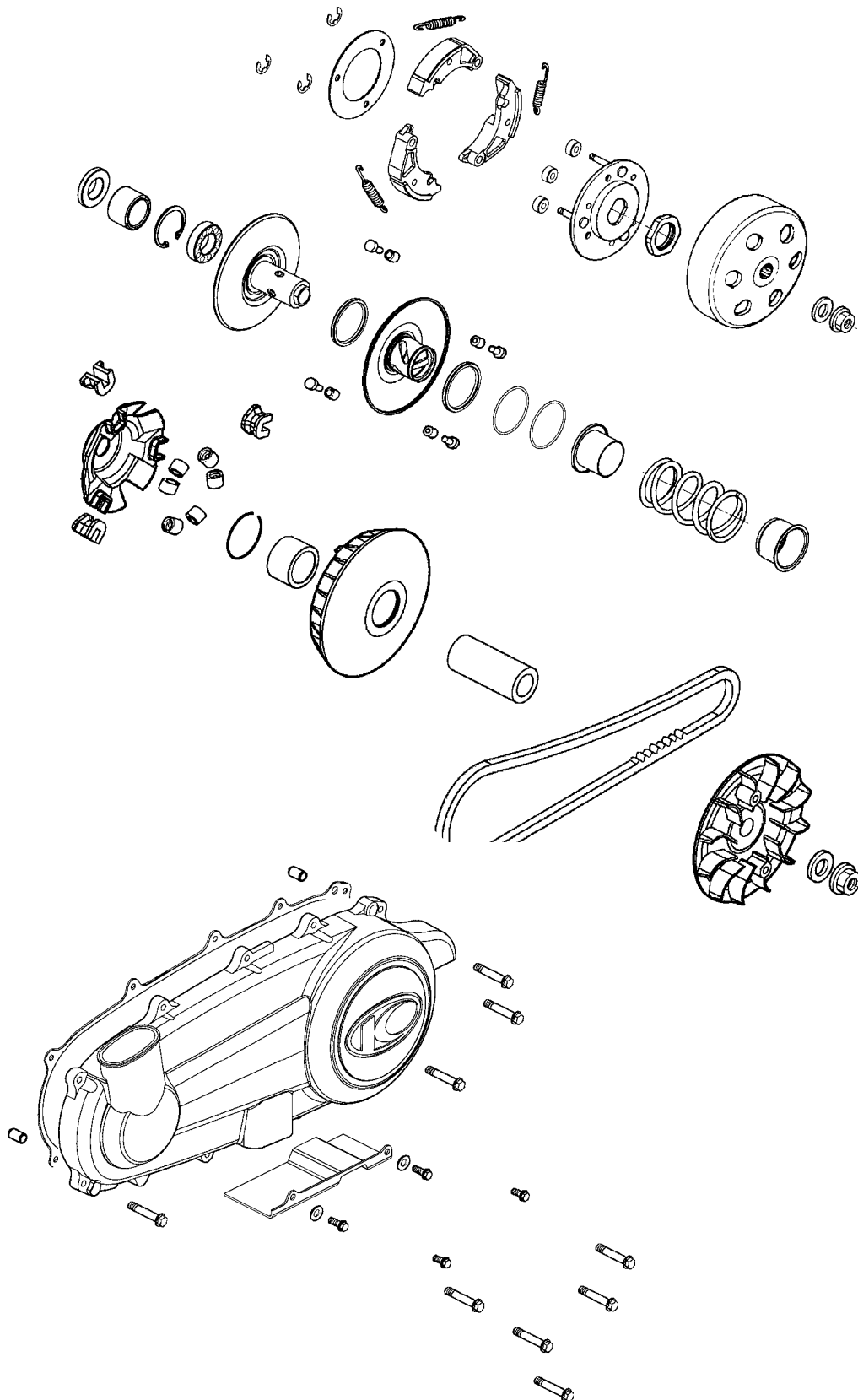

8. DRIVE AND DRIVEN PULLEYS/ V-BELT

SERVICE INFORMATION

GENERAL INSTRUCTIONS

- The drive pulley, clutch and driven pulley can be serviced with the engine installed.
- Avoid getting grease and oil on the drive belt and pulley faces. Remove any oil or grease from them to minimize the slipping of drive belt and drive pulley.

SPECIFICATIONS

Item	Standard (mm)	Service Limit (mm)
Movable driven face bushing I.D.	40.000~40.025	40.06
Driven face collar O.D.	39.965~39.955	39.85
Drive belt width	23.6~24.4	22.0
Clutch lining thickness	3.963~4.037	2.0
Clutch outer I.D.	153.0~153.2	153.5
Weight roller O.D.	22.92~23.08	22.0
Drive pulley collar O.D.	26.960~26.974	26.90

TORQUE VALUES

Drive face nut	88.2~98N-m
Clutch outer nut	49.0~58.8N-m
Clutch drive plate nut	49.0~58.8N-m

SPECIAL TOOLS

Universal holder	E017
Clutch spring compressor	E034

TROUBLESHOOTING

Engine starts but motorcycle won't move

- Worn drive belt
- Broken ramp plate
- Worn or damaged clutch lining
- Broken driven face spring

Lack of power

- Worn drive belt
- Weak driven face spring
- Worn weight roller
- Faulty driven face

Engine stalls or motorcycle creeps

- Broken clutch weight spring

8. DRIVE AND DRIVEN PULLEYS/ V-BELT

LEFT CRANKCASE COVER

REMOVAL

Remove the met-in box and carrier. (⇒2-6)
Remove the body cover, center cover and rear fender A together. (⇒2-6)
Disconnect the belt air tube from the frame

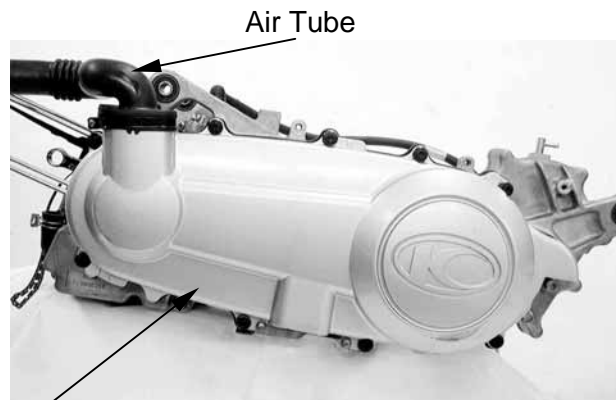

Left Crankcase

Remove the left crankcase cover bolts and left crankcase covers.
Remove the seal rubber and dowel pins.

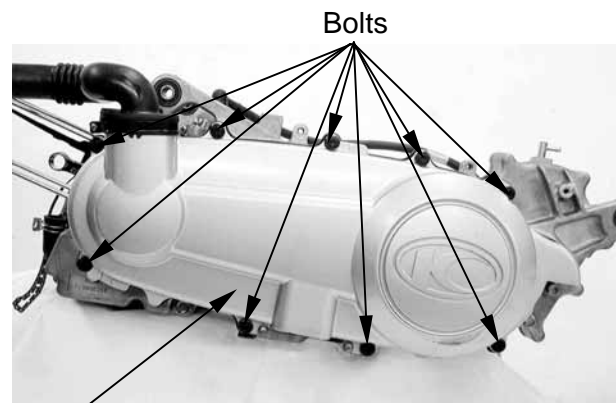

Left Crankcase Cover

INSTALLATION

Install the dowel pins and the seal rubber.

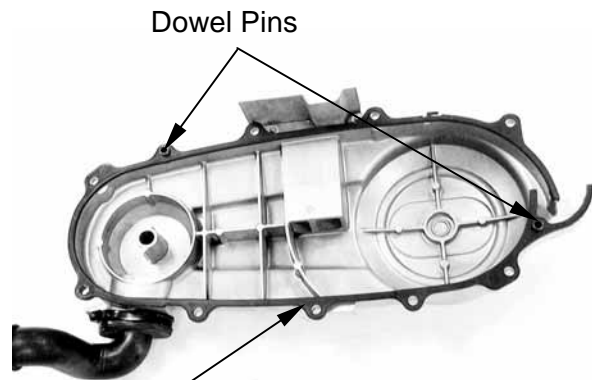

Seal Rubber

Install the left crankcase cover.
Install and tighten the left crankcase cover bolts.

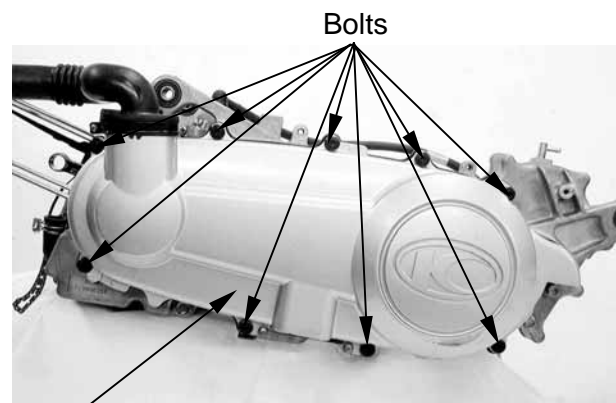

Left Crankcase Cover

8. DRIVE AND DRIVEN PULLEYS/ V-BELT

Connect the drive belt air tube to frame.

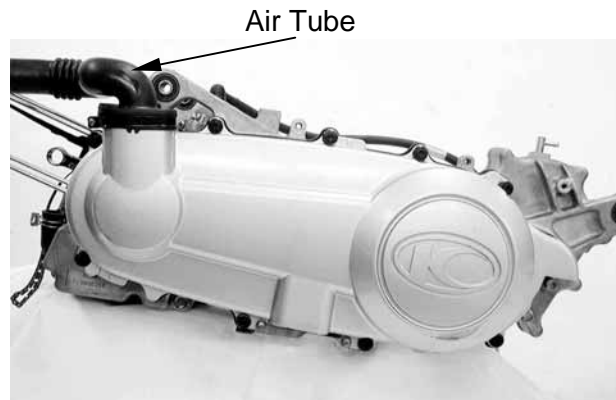

DRIVE PULLEY

DRIVE PULLEY FACE REMOVAL

Remove the left crankcase cover. (⇒8-3)
Hold the drive pulley using a universal holder
and remove the drive face nut and washer.
Remove the drive pulley face.

Special

Universal HolderE017

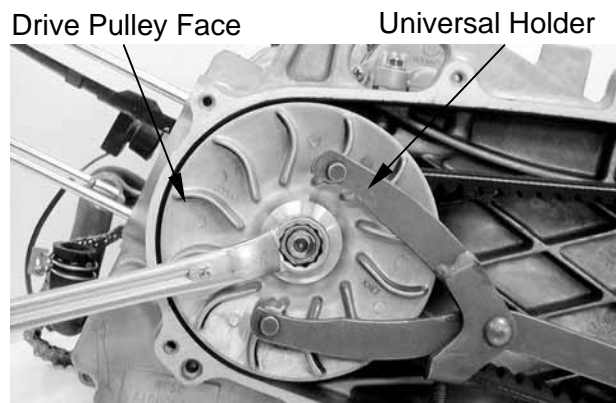

CLUTCH OUTER/DRIVEN PULLEY/V-BELT REMOVAL

Remove the left crankcase cover. (⇒8-3)
Remove the drive pulley face. (⇒8-4)
Hold the clutch outer with the universal holder
and remove the clutch outer nut and washer.

Special

Universal HolderE017

Remove the clutch outer, driven pulley and
belt together.

Remove the drive belt from the movable drive
face.

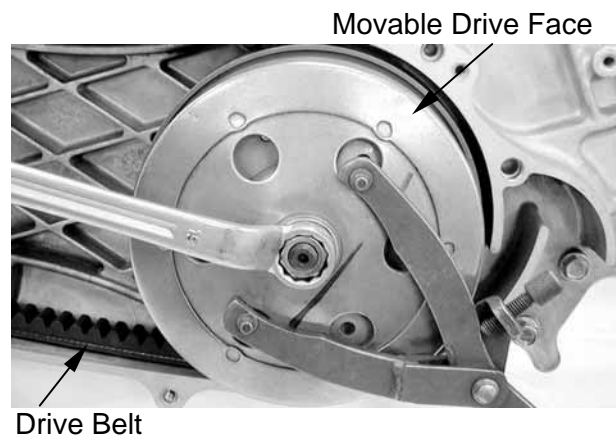

INSPECTION

Check the drive belt for cracks, separation or
abnormal or excessive wear.
Measure the drive belt width.

Service Limit: 22.0mm replace if below

- * • Use specified genuine parts for replacement.



8. DRIVE AND DRIVEN PULLEYS/ V-BELT

MOVABLE DRIVE FACE ASSEMBLY

Remove the pulley face, clutch outer, driven pulley and belt. (⇒8-4))

Remove the movable drive face assembly.
Remove the drive pulley collar.

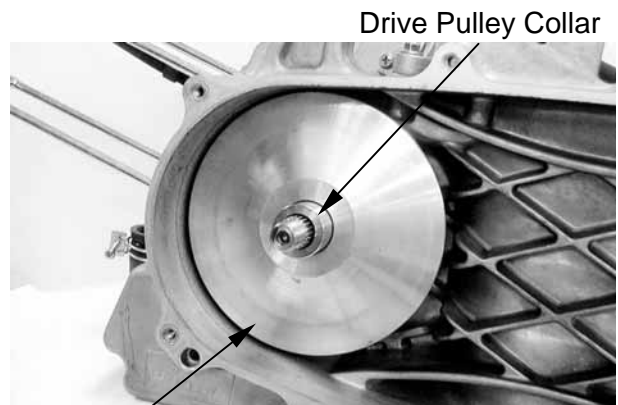

DISASSEMBLY

Remove the ramp plate.

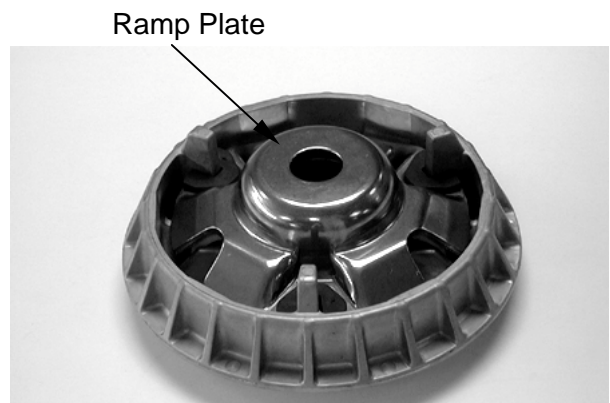

Remove the weight rollers.

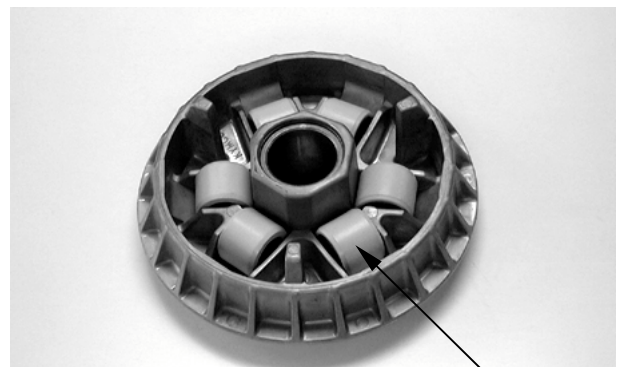

INSPECTION

Check each weight roller for wear or damage.
Measure each weight roller O.D.

Service Limit: 22.00mm replace if below

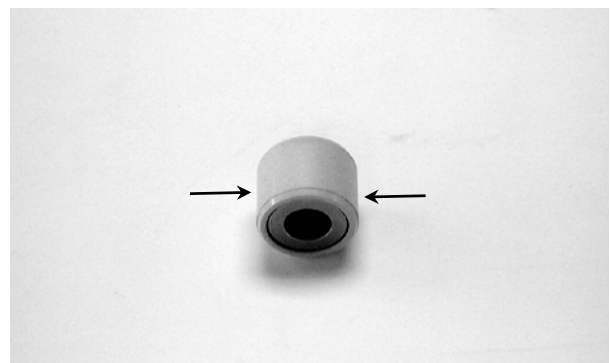

8. DRIVE AND DRIVEN PULLEYS/ V-BELT

Measure the movable drive face bushing assembly I.D.

Service Limit: 27.13mm replace if over

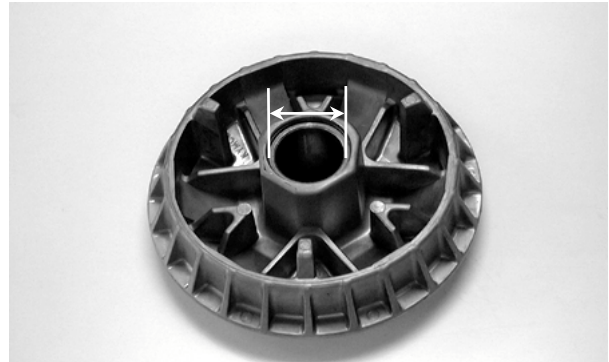

Check the drive pulley collar for wear or damage.
Measure the O.D. of the drive pulley collar sliding surface.

Service Limit: 26.90mm replace if below

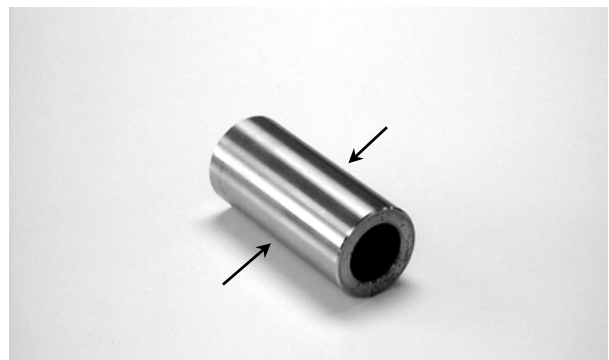

ASSEMBLY

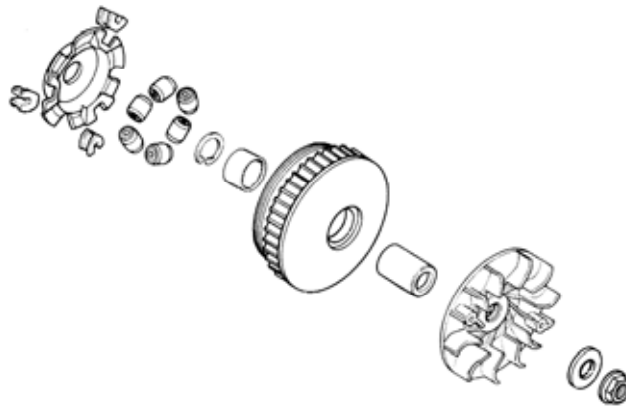

Install the weight rollers into the movable drive face.

- * The direction of all weight rolls is same. The color side is towards to clockwise.



Weight Roller

8. DRIVE AND DRIVEN PULLEYS/ V-BELT

Install the ramp plate.

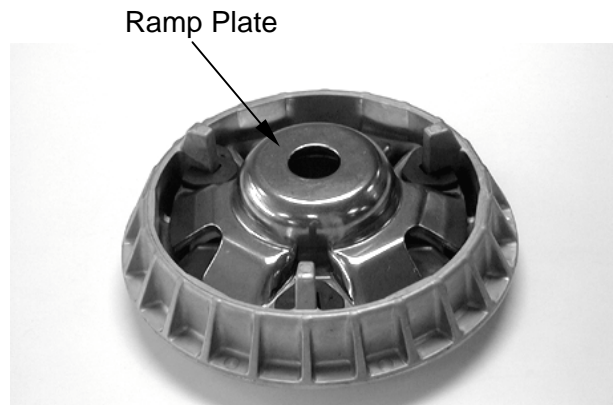

Insert the drive pulley collar into the movable drive face.

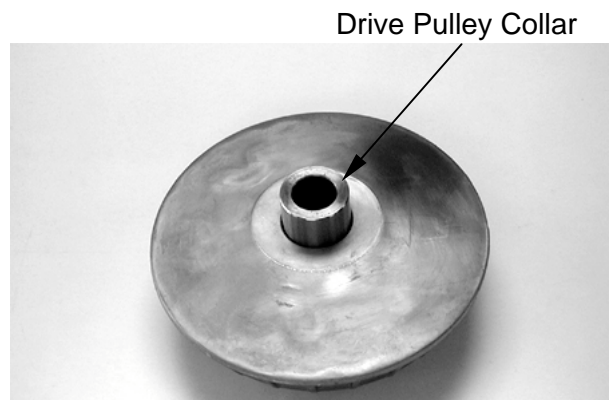

INSPECTION

Inspect the clutch outer for wear or damage.
Measure the clutch outer I.D.

Service Limit: 153.5mm replace if over

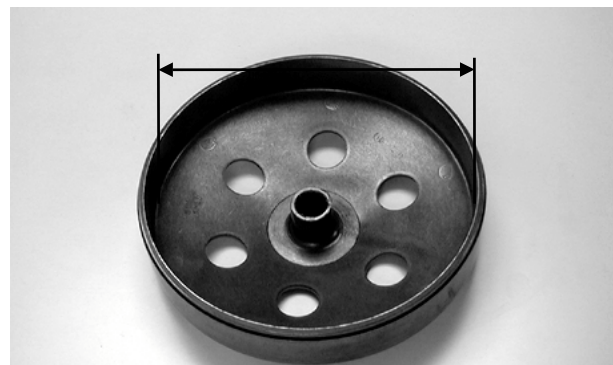

8. DRIVE AND DRIVEN PULLEYS/ V-BELT

Check the clutch shoes for wear or damage.
Measure the clutch lining thickness.

Service Limit: 2.0mm replace if below

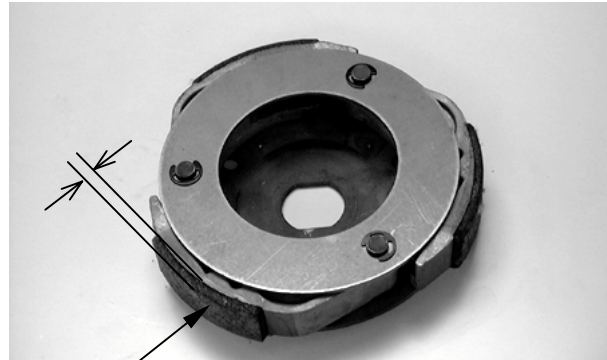

Clutch Lining

CLUTCH/DRIVEN PULLEY DISASSEMBLY



Clutch/Driven Pulley

Hold the clutch/driven pulley assembly with
the clutch spring compressor.

- * Be sure to use a clutch spring compressor to avoid spring damage.

Special

Clutch Spring Compressor E034

Set the tool in a vise and remove the clutch
drive plate nut.

Lock Nut Wrench, 39mm

Clutch Spring Compressor Lock Nut Wrench



Loosen the clutch spring compressor and
disassemble the clutch/driven pulley
assembly.

Remove the seal collar.



8. DRIVE AND DRIVEN PULLEYS/ V-BELT

Pull out the guide roller pins and guide rollers.
Remove the movable driven face from the
driven face.

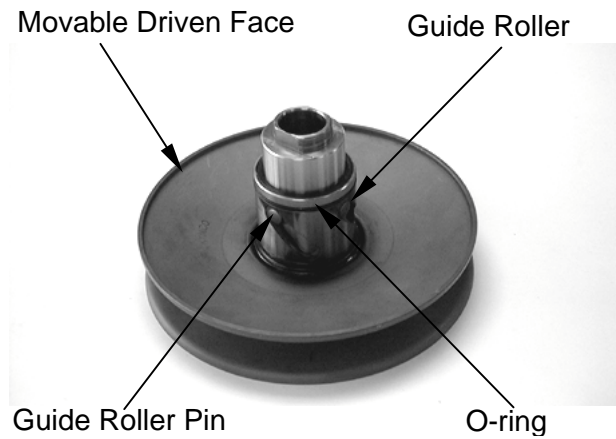

Remove the oil seal from the movable driven
face.

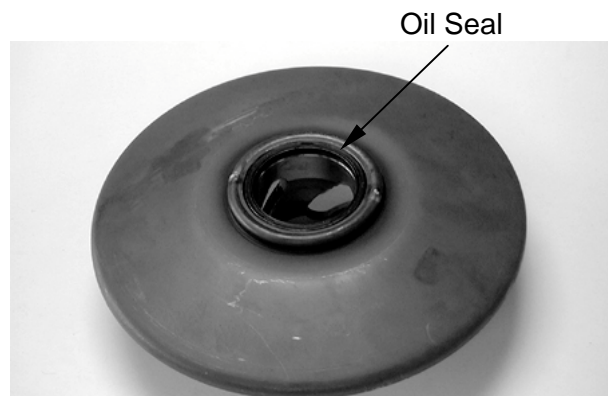

INSPECTION

Measure the driven face spring free length.
Service Limit: 130.5mm replace if below

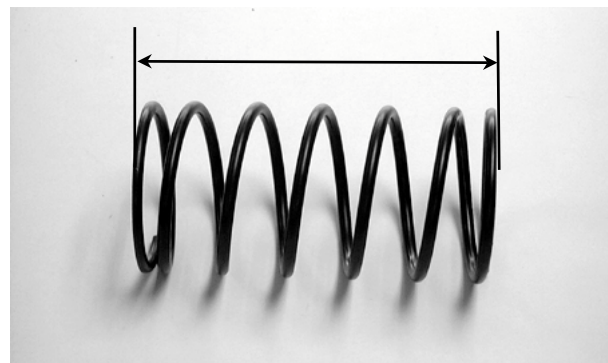

Check the driven face assembly for wear or
damage.
Measure the driven face O.D.
Service Limit: 39.85mm replace if below

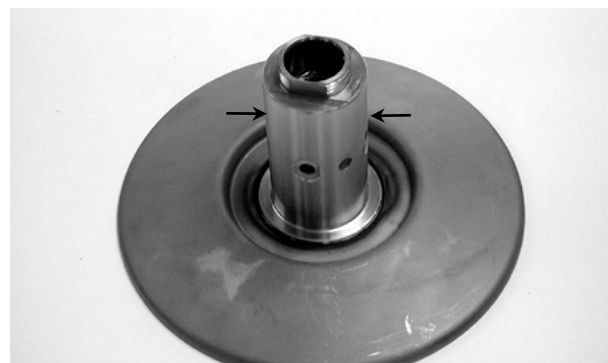

8. DRIVE AND DRIVEN PULLEYS/ V-BELT

Check the movable driven face for wear or damage.

Measure the movable driven face I.D.

Service Limit: 40.06mm replace if over

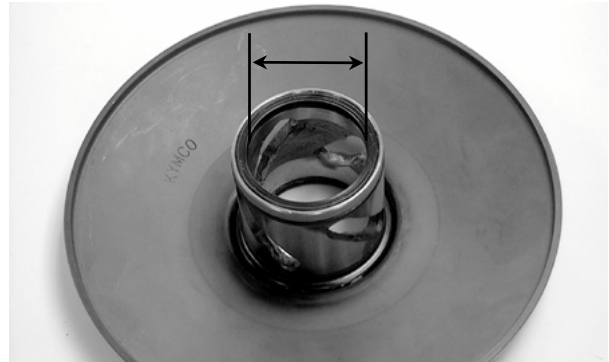

DRIVEN PULLEY FACE BEARING REPLACEMENT

Check the bearings for play and replace them if they have excessive play.

Drive the inner needle bearing out of the driven pulley face.

- * Discard the removed bearing and replace with a new one.

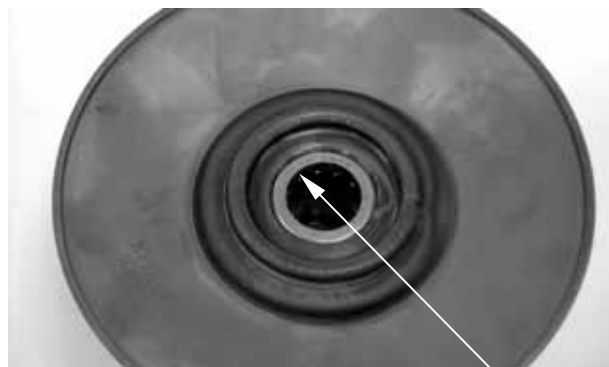

Inner Bearing

Remove the snap ring and drive the outer bearing out of the driven face.

- * Discard the removed bearing and replace with a new one.

Apply grease to the outer bearing.
Drive a new outer bearing into the driven face with the sealed end facing up.

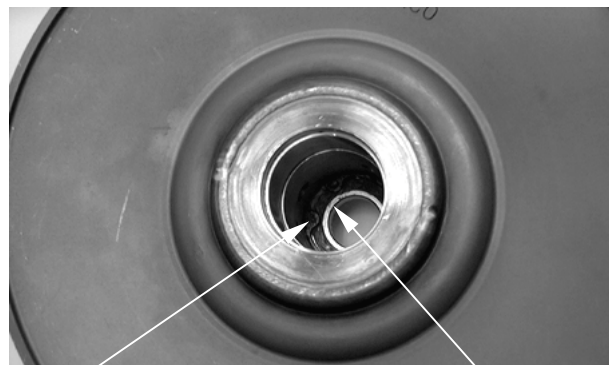

Snap Ring

Outer Bearing

Seat the snap ring in its groove.
Apply grease to the driven face bore areas.

- * Pack all bearing cavities with 9~9.5g grease.

8. DRIVE AND DRIVEN PULLEYS/ V-BELT

Press a new needle bearing into the driven face.

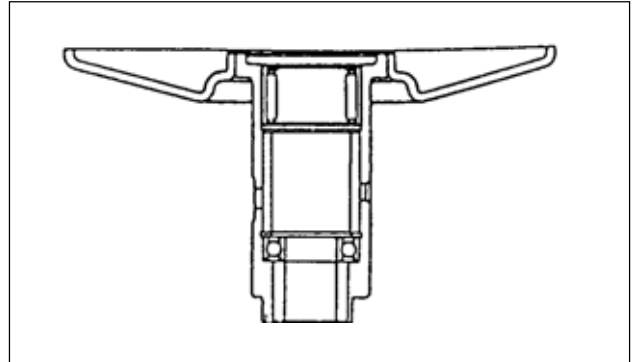

CLUTCH DISASSEMBLY

Remove the circlips and retainer plate to disassemble the clutch.

- * • Keep grease off the clutch linings.

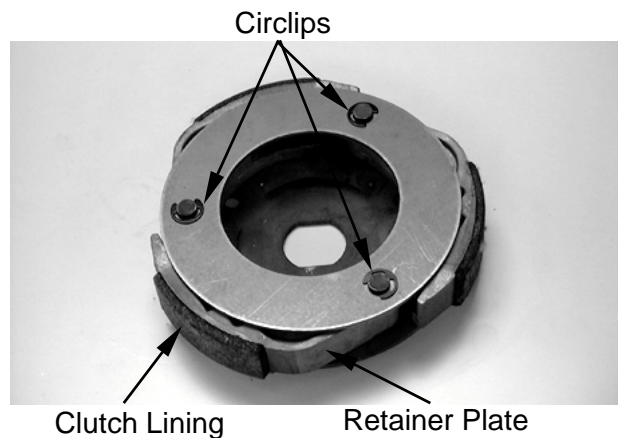

8. DRIVE AND DRIVEN PULLEYS/ V-BELT

CLUTCH ASSEMBLY

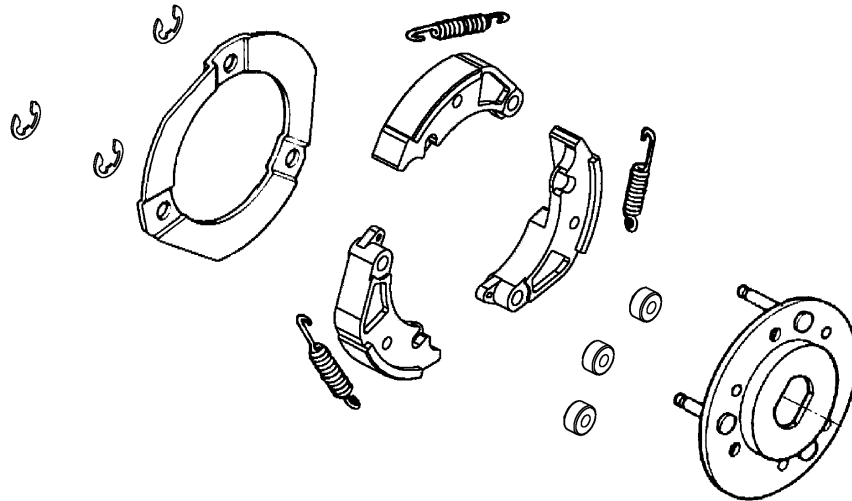

Install the damper rubbers on the drive plate pins.
Install the clutch weights/shoes and clutch springs onto the drive plate.
Install the retainer plate and secure with the circlips.

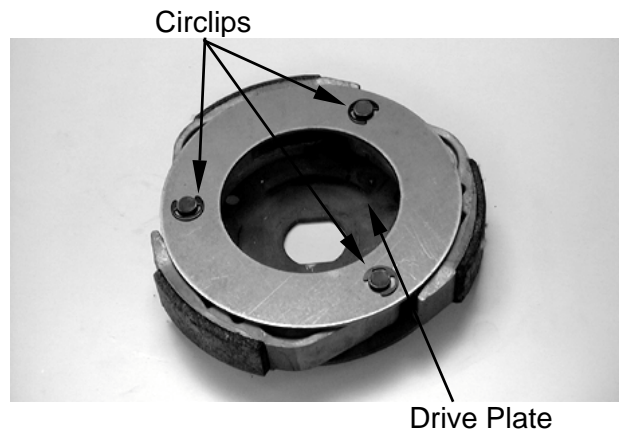

CLUTCH/DRIVEN PULLEY ASSEMBLY

Clean the pulley faces and remove any grease from them.
Apply grease to the O-rings and install them onto the moveable driven face.

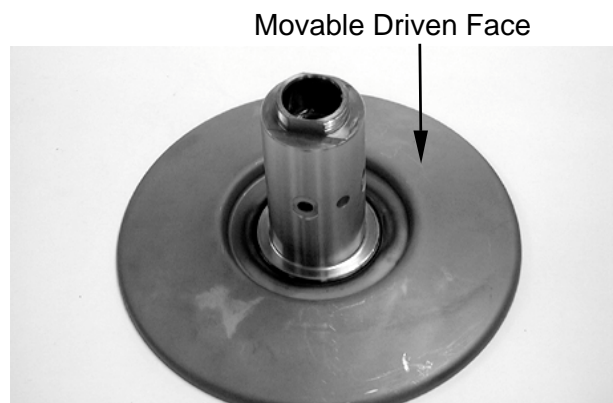

8. DRIVE AND DRIVEN PULLEYS/ V-BELT

Install the movable driven face onto the driven face.
Apply grease to the guide rollers and guide roller pins and then install them into the holes of the driven face.

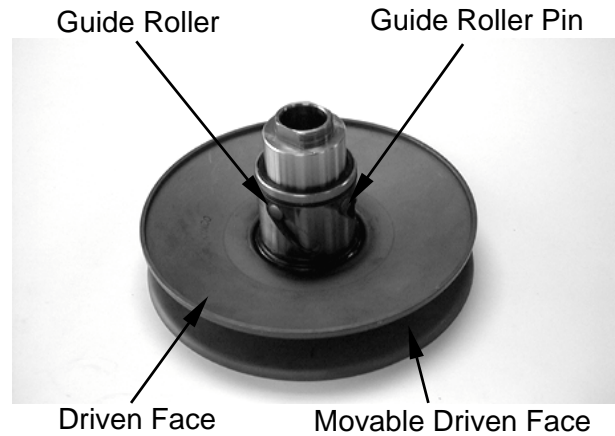

Install the seal collar.
Remove any excessive grease.

- * Be sure to clean the driven face off any grease.

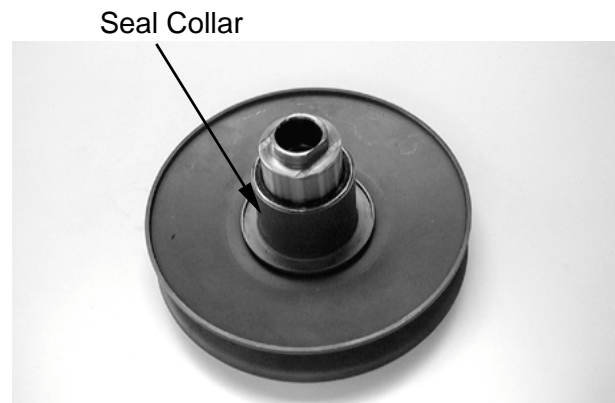

Set the driven pulley assembly, driven face spring and clutch assembly onto the clutch spring compressor.

- * Align the flat surface of the driven face with the flat on the clutch drive plate.

Compress the tool and install the drive plate nut.

Set the tool in a vise and tighten the drive plate nut to the specified torque.

Torque: 49.0~58.8N-m

- * Be sure to use a clutch spring compressor to avoid spring damage.

Special

Clutch Spring Compressor

E034

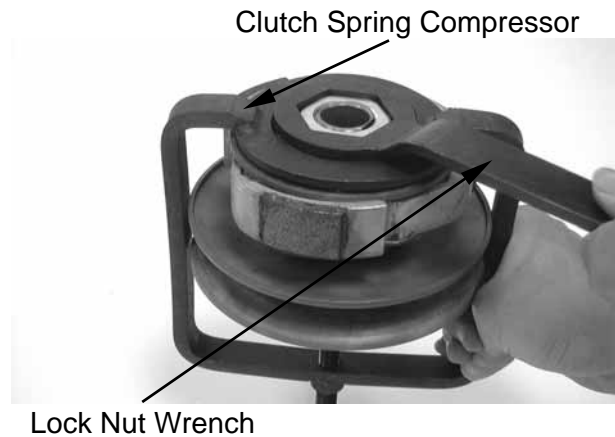

8. DRIVE AND DRIVEN PULLEYS/ V-BELT

INSTALLATION

Install the movable drive face assembly and drive pulley collar onto the crankshaft.

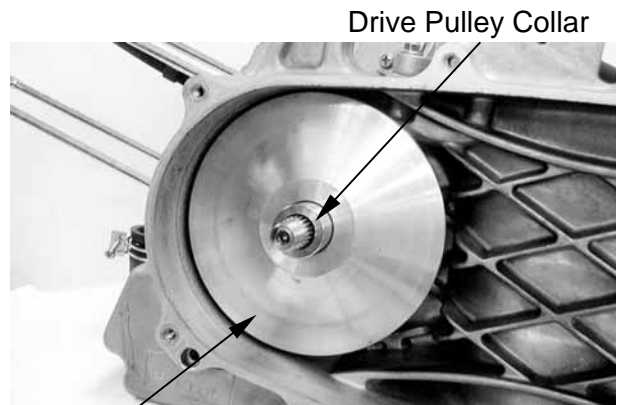

Lay the drive belt on the driven pulley.
Set the drive belt on the drive pulley collar.
Install the clutch/driven pulley and clutch outer onto the drive shaft.

- * • Keep grease off the drive shaft.

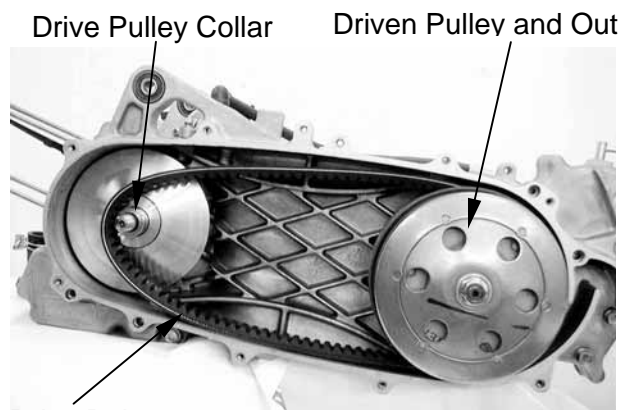

Install washer and the clutch outer nut.
Hold the clutch outer with the universal holder
to tighten clutch outer nut.
Torque: 49.0~58.8kg-m

Special

Universal HolderE017

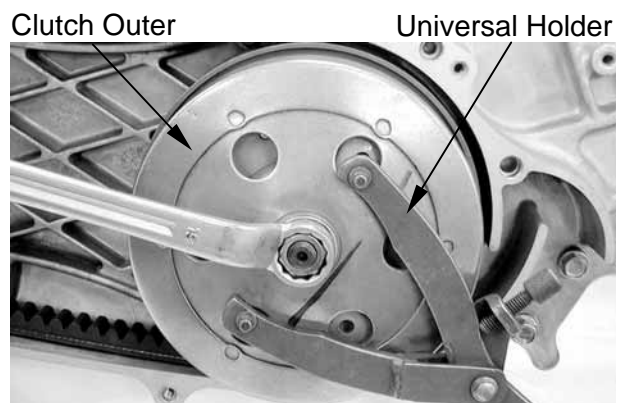

Install the drive pulley face, washer and drive face nut.
Hold the drive pulley with the universal holder
and tighten the drive face nut.

Torque: 88.2~98N-m

Special

Universal HolderE017

- * • Do not get oil or grease on the drive belt or drive pulley faces.

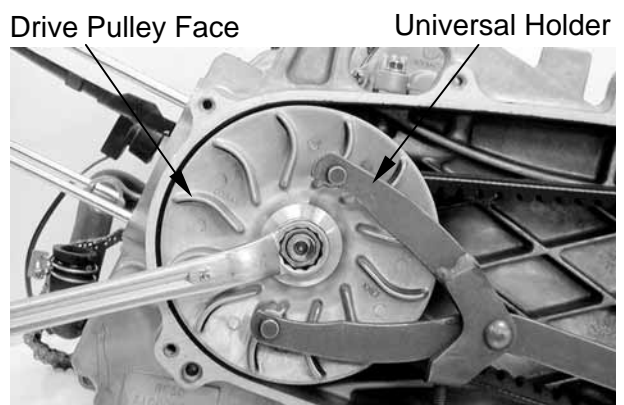

8. DRIVE AND DRIVEN PULLEYS/ V-BELT

Install the left crankcase cover. (⇒8-3)

