



Bobcat®

Service Manual

S70 Skid-Steer Loader

S/N A3W611001 & Above
S/N A3W711001 & Above

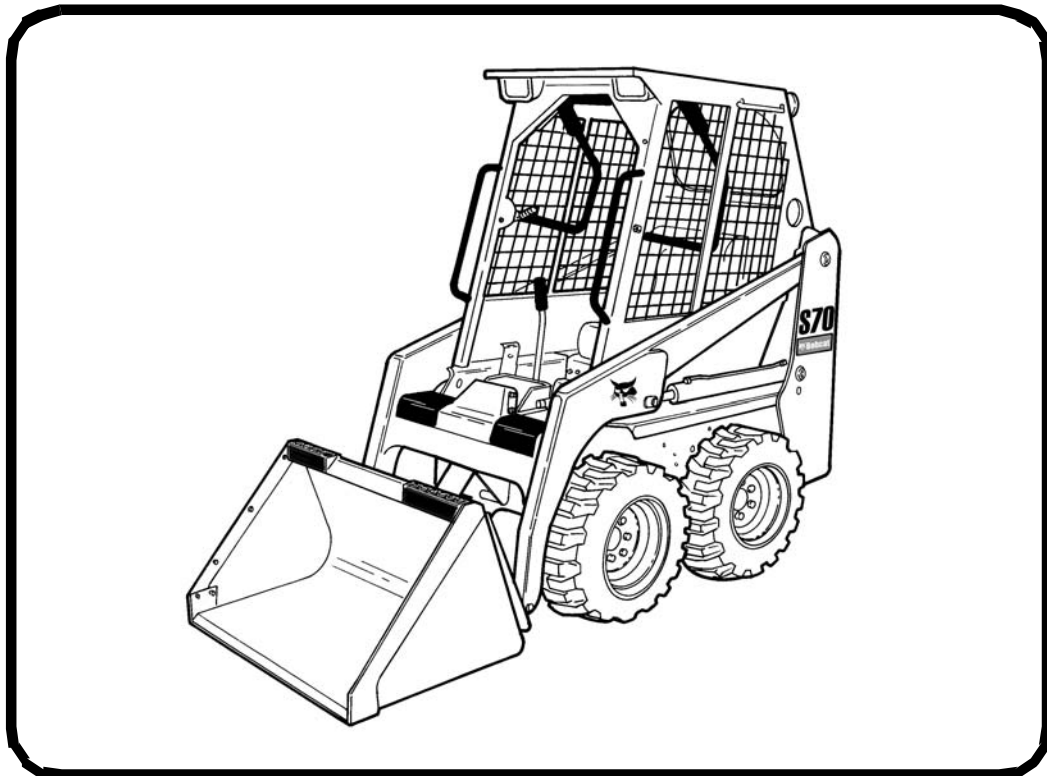

EQUIPPED WITH
BOBCAT INTERLOCK

CONTROL SYSTEM (BICS™) 420 pages at:

<https://www.arepairmanual.com/downloads/bobcat-s70-skid-steer-loader-service-repair-workshop-manual-a3w611001-a3w711001-2/>



Product: Bobcat S70 Skid Steer Loader Service Repair Workshop Manual A3W611001-A3W711001

Full Download: [https://www.arepairmanual.com/downloads/bobcat-s70-skid-steer-loader-service-repair-workshop-manual-a3w611001-a3w711001-](https://www.arepairmanual.com/downloads/bobcat-s70-skid-steer-loader-service-repair-workshop-manual-a3w611001-a3w711001-2/)

[2/](https://www.arepairmanual.com/downloads/bobcat-s70-skid-steer-loader-service-repair-workshop-manual-a3w611001-a3w711001-2/)

Sample of manual. Download All 420 pages at:

[https://www.arepairmanual.com/downloads/bobcat-s70-skid-steer-loader-service-repair-workshop-manual-a3w611001-a3w711001-](https://www.arepairmanual.com/downloads/bobcat-s70-skid-steer-loader-service-repair-workshop-manual-a3w611001-a3w711001-2/)

MAINTENANCE SAFETY



WARNING

Instructions are necessary before operating or servicing machine. Read and understand the Operation & Maintenance Manual, Operator's Handbook and signs (decals) on machine. Follow warnings and instructions in the manuals when making repairs, adjustments or servicing. Check for correct function after adjustments, repairs or service. Untrained operators and failure to follow instructions can cause injury or death.

W-2003-0903



Safety Alert Symbol: This symbol with a warning statement, means: "Warning, be alert! Your safety is involved!" Carefully read the message that follows.

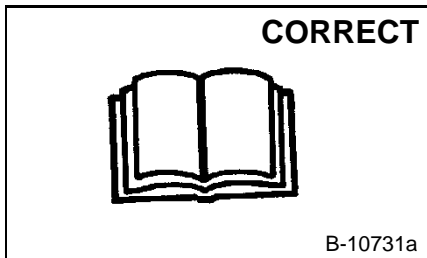

Never service the Bobcat Skid-Steer Loader without instructions.

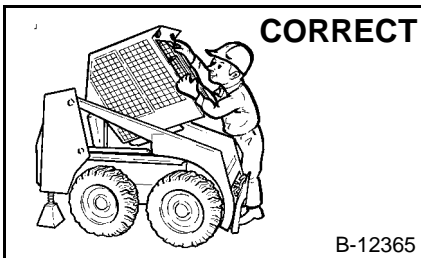

Use the correct procedure to lift or lower operator cab.

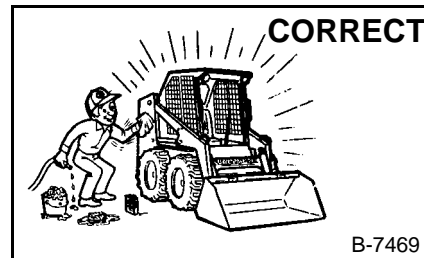

Cleaning and maintenance are required daily.

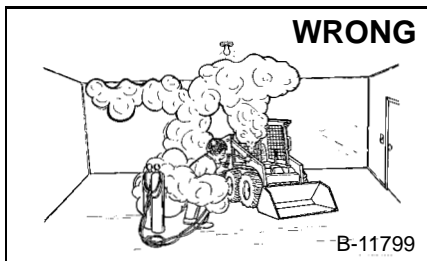

- Have good ventilation when welding or grinding painted parts.
- Wear dust mask when grinding painted parts. Toxic dust and gas can be produced.
- Avoid exhaust fume leaks which can kill without warning. Exhaust system must be tightly sealed.

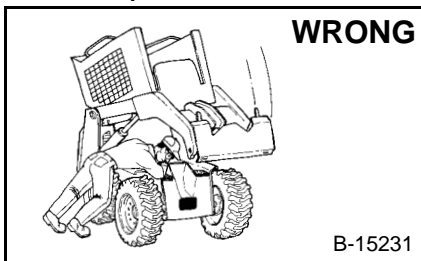

Disconnecting or loosening any hydraulic tubeline, hose, fitting, component or a part failure can cause lift arms to drop. Do not go under lift arms when raised unless supported by an approved lift arm support device. Replace it if damaged.

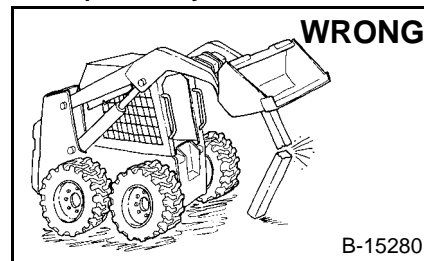

- Never work on loader with lift arms up unless lift arms are held by an approved lift arm support device. Replace if damaged.
- Never modify equipment or add attachments not approved by Bobcat Company.

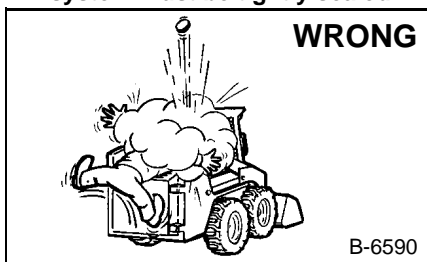

- Stop, cool and clean engine of flammable materials before checking fluids.
- Never service or adjust loader with the engine running unless instructed to do so in the manual.
- Avoid contact with leaking hydraulic fluid or diesel fuel under pressure. It can penetrate the skin or eyes.
- Never fill fuel tank with engine running, while smoking or when near open flame.

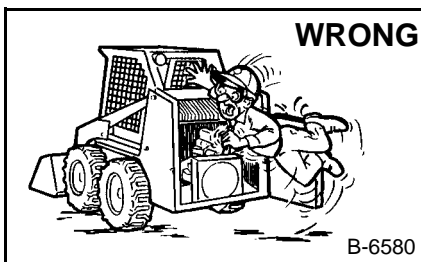

- Keep body, jewelry and clothing away from moving parts, electrical contact, hot parts and exhaust.
- Wear eye protection to guard from battery acid, compressed springs, fluids under pressure and flying debris when engines are running or tools are used. Use eye protection approved for type of welding.
- Keep rear door closed except for service. Close and latch door before operating the loader.



- Lead-acid batteries produce flammable and explosive gases.
- Keep arcs, sparks, flames and lighted tobacco away from batteries.
- Batteries contain acid which burns eyes or skin on contact. Wear protective clothing. If acid contacts body, flush well with water. For eye contact flush well and get immediate medical attention.

Maintenance procedures which are given in the Operation & Maintenance Manual can be performed by the owner/operator without any specific technical training. Maintenance procedures which are **not** in the Operation & Maintenance Manual must be performed **ONLY BY QUALIFIED BOBCAT SERVICE PERSONNEL**. Always use genuine Bobcat replacement parts. The Service Safety Training Course is available from your Bobcat dealer.



Bobcat®

ALPHABETICAL INDEX

AIR CLEANER	70-01	HYDROSTATIC PUMP	30-01
AIR CLEANER SERVICE	10-01	HYDROSTATIC SYSTEM INFORMATION	30-01
ALTERNATOR	60-01		
AUXILIARY CONTROL LOCKBOLT	10-01	INSTRUMENT PANEL.....	60-01
AUXILIARY HYDRAULIC INTERLOCK VALVE	20-01		
		LIFT ARMS	50-01
BATTERY	60-01	LIFT ARM BY-PASS CONTROL VALVE.....	20-01
BICS™ CONTROLLER (GATEWAY).....	60-01	LIFT ARM SUPPORT DEVICE	10-01
BICS™ SYSTEM	60-01	LIFTING AND BLOCKING THE LOADER.....	10-01
BOB-TACH	10-01, 50-01	LIGHTS	60-01
BRAKE	40-01	LOADER SPECIFICATIONS	SPEC-01
		LOADER STORAGE AND RETURN TO SERVICE	10-01
CAMSHAFT AND TIMING GEARS.....	70-01	LUBRICATING THE LOADER.....	10-01
CHAINCASE	40-01	LUBRICATION SYSTEM.....	70-01
CHARGE PRESSURE	30-01		
CONTROLS	20-01	MAIN RELIEF VALVE	20-01
CONTROL LEVER.....	50-01	MUFFLER.....	70-01
CONTROL PANEL.....	50-01		
CONVERSIONS	SPEC-01	OIL COOLER	20-01
CRANKSHAFT AND PISTONS	70-01	OPERATOR CAB	10-01, 50-01
CYLINDER HEAD.....	70-01	OPERATOR SEAT.....	50-01
CYLINDER (LIFT)	20-01		
CYLINDER (TILT)	20-01	PARKING BRAKE.....	40-01
		PIVOT PINS	10-01
DRIVE BELT	30-01		
DRIVE COMPONENTS	40-01	REAR DOOR.....	50-01
		REAR WINDOW	50-01
ELECTRICAL SYSTEM INFORMATION	60-01	RECONDITIONING THE ENGINE	70-01
ENGINE	70-01	REGULAR MAINTENANCE	80-01
ENGINE COMPONENTS AND TESTING	70-01	REMOTE START SWITCH	10-01
ENGINE COOLING SYSTEM.....	10-01, 70-01		
ENGINE INFORMATION	70-01	SEAT BAR RESTRAINT SYSTEM.....	10-01
ENGINE LUBRICATION SYSTEM.....	10-01	SEAT BAR	50-01
ENGINE SPEED CONTROL	70-01	SEAT BAR SENSOR	60-01
		SERVICE SCHEDULE	10-01
FINAL DRIVE TRANSMISSION (CHAINCASE)	10-01	SPARK ARRESTOR MUFFLER.....	10-01
FLYWHEEL AND HOUSING	70-01	STARTER	60-01
FUEL SYSTEM	10-01, 70-01	STEERING	30-01
FUEL TANK.....	50-01		
		TIRE MAINTENANCE	10-01
HEATER COIL	80-01	TORQUE SPECIFICATIONS FOR BOLTS	SPEC-01
HEATER FAN.....	80-01	TOWING THE LOADER	10-01
HEATER SWITCH.....	80-01	TRACTION LOCK	60-01
HEATER SYSTEM.....	80-01	TRANSPORTING THE LOADER ON A TRAILER	10-01
HEATER UNIT	80-01	TROUBLESHOOTING	80-01
HEATER VALVE.....	80-01		
HYDRAULIC CONNECTION SPECS	SPEC-01	WINDOWS (REAR)	50-01
HYDRAULIC CONTROL VALVE.....	20-01		
HYDRAULIC/HYDROSTAIC FILTER.....	20-01		
HYDRAULIC/HYDROSTAIC FLUID SPECIFICATIONS	SPEC-01		
HYDRAULIC PUMP	20-01		
HYDRAULIC FLUID RESERVOIR.....	20-01		
HYDRAULIC SYSTEM INFORMATION.....	20-01		
HYDRAULIC/HYDROSTATIC SYSTEM	10-01		
HYDROSTATIC MOTOR	30-01		



Bobcat®

CONTENTS

FOREWORD.....	II
SAFETY INSTRUCTIONS	V
FIRE PREVENTION	VII
SERIAL NUMBER LOCATIONS	IX
DELIVERY REPORT.....	IX
BOBCAT LOADER IDENTIFICATION.....	X
SAFETY AND MAINTENANCE.....	10-01
HYDRAULIC SYSTEM	20-01
HYDROSTATIC SYSTEM.....	30-01
DRIVE SYSTEM	40-01
MAIN FRAME	50-01
ELECTRICAL SYSTEM & ANALYSIS.....	60-01
ENGINE SERVICE	70-01
HEATER	80-01
SPECIFICATIONS.....	SPEC-01

**SAFETY &
MAINTENANCE**

**HYDRAULIC
SYSTEM**

**HYDROSTATIC
SYSTEM**

**DRIVE
SYSTEM**

MAIN FRAME

**ELECTRICAL
SYSTEM &
ANALYSIS**

**ENGINE
SERVICE**

HEATER

SPECIFICATIONS

FOREWORD

This manual is for the Bobcat loader mechanic. It provides necessary servicing and adjustment procedures for the Bobcat loader and its component parts and systems. Refer to the Operation & Maintenance Manual for operating instructions, starting procedure, daily checks, etc.

A general inspection of the following items must be made after the loader has had service or repair:

1. Check that the ROPS/FOPS (Including side screens) is in good condition and is not modified.

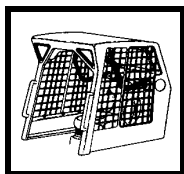

9. The parking brake must function correctly.

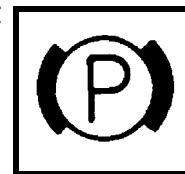

2. Check that ROPS mounting hardware is tightened and is Bobcat approved.

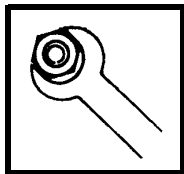

10. Enclosure door latches must open and close freely.

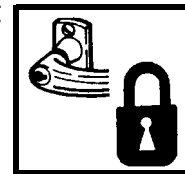

3. The seat belt must be correctly installed, functional and in good condition.

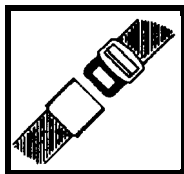

11. Bob-Tach wedges and linkages must function correctly and be in good condition.

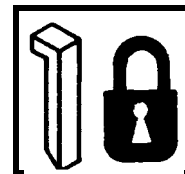

4. The seat bar must be correctly adjusted, clean and lubricated.

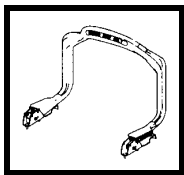

12. Safety treads must be in good condition.

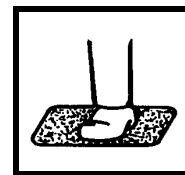

5. Check lift arm support device, replace if damaged.



13. Check for correct function of indicator lamps.

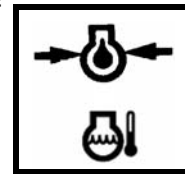

6. Machine signs (decals) must be legible and in the correct location.



14. Check hydraulic fluid level, engine oil level and fuel supply.

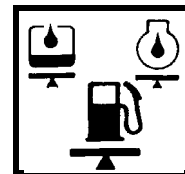

7. Steering levers, hand controls and foot pedals must return to neutral (as applicable).

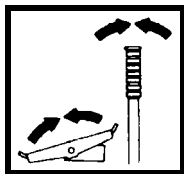

15. Inspect for fuel, oil or hydraulic fluid leaks.

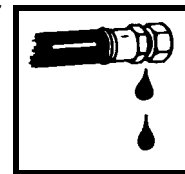

8. Check for correct function of the work lights.



16. Lubricate the loader.

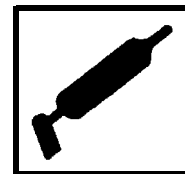

FW SSL-0308 SM

17. Check the condition of the battery and cables.

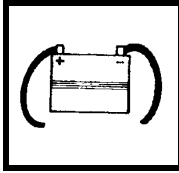

18. Inspect the air cleaner for damage or leaks. Check the condition of the element.

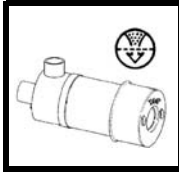

19. Check the electrical charging system.

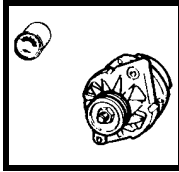

20. Check tires for wear and pressure. Check tracks for wear and tension. Use only approved tires or tracks.

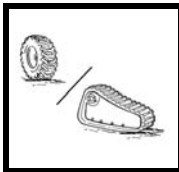

21. Inspect for loose or broken parts or connections.

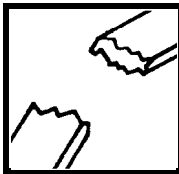

22. Check for any field modification not completed.



23. Operate the machine and check all functions.

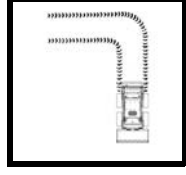

24. Check for correct function of the Bobcat Interlock Control System (BICST™) before the machine is returned to the customer.

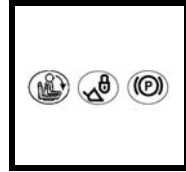

25. Check function or condition of all equipped options and accessories (examples: back-up alarm, fire extinguisher, rotating beacon, lift kits, etc.).



26. Recommend to the owner that all necessary corrections be made before the machine is returned to service.

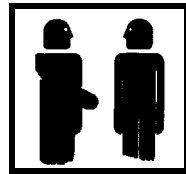

**CALIFORNIA
PROPOSITION 65 WARNING**
Diesel engine exhaust and some of its constituents are known to the state of California to cause cancer, birth defects and other reproductive harm.



Bobcat®

SAFETY INSTRUCTIONS



Safety Alert Symbol

This symbol with a warning statement means: **“Warning, be alert! Your safety is involved!”**
Carefully read the message that follows.



WARNING

Instructions are necessary before operating or servicing machine. Read and understand the Operation & Maintenance Manual, Operator's Handbook and signs (decals) on machine. Follow warnings and instructions in the manuals when making repairs, adjustments or servicing. Check for correct function after adjustments, repairs or service. Untrained operators and failure to follow instructions can cause injury or death.

W-2003-0903

IMPORTANT

This notice identifies procedures which must be followed to avoid damage to the machine.

I-2019-0284



DANGER

The signal word DANGER on the machine and in the manuals indicates a hazardous situation which, if not avoided, will result in death or serious injury.

D-1002-1107



WARNING

The signal word WARNING on the machine and in the manuals indicates a potentially hazardous situation which, if not avoided, could result in death or serious injury.

W-2044-1107

The following publications provide information on the safe use and maintenance of the Bobcat machine and attachments:

- The Delivery Report is used to assure that complete instructions have been given to the new owner and that the machine is in safe operating condition.
- The Operation & Maintenance Manual delivered with the machine or attachment contains operating information as well as routine maintenance and service procedures. It is a part of the machine and can be stored in a container provided on the machine. Replacement Operation & Maintenance Manuals can be ordered from your Bobcat dealer.
- Machine signs (decals) instruct on the safe operation and care of your Bobcat machine or attachment. The signs and their locations are shown in the Operation & Maintenance Manual. Replacement signs are available from your Bobcat dealer.
- An Operator's Handbook fastened to the operator cab. It's brief instructions are convenient to the operator. The handbook is available from your dealer in an English edition or one of many other languages. See your Bobcat dealer for more information on translated versions.
- The AEM Safety Manual delivered with the machine gives general safety information.
- The Service Manual and Parts Manual are available from your dealer for use by mechanics to do shop-type service and repair work.
- The Skid-Steer Loader Operator Training Course is available through your local dealer or at www.training.bobcat.com or www.bobcat.com. This course is intended to provide rules and practices of correct operation of the Skid-Steer Loader. The course is available in English and Spanish versions.
- Service Safety Training Courses are available from your Bobcat dealer or at www.training.bobcat.com or www.bobcat.com. They provide information for safe and correct service procedures.
- The Skid-Steer Loader Safety Video is available from your Bobcat dealer or at www.training.bobcat.com or www.bobcat.com.

SI SSL-0308 SM

SAFETY INSTRUCTIONS (CONT'D)

The dealer and owner / operator review the recommended uses of the product when delivered. If the owner / operator will be using the machine for a different application(s) he or she must ask the dealer for recommendations on the new use.



Cutting or drilling concrete containing sand or rock containing quartz may result in exposure to silica dust. Do not exceed Permissible Exposure Limits (PEL) to silica dust as determined by OSHA or other job site Rules and Regulations. Use a respirator, water spray or other means to control dust. Silica dust can cause lung disease and is known to the state of California to cause cancer.

Call Before You Dig
Dial 811 (USA Only)
1-888-258-0808 (USA & Canada)

When you call, you will be directed to a location in your state / province, or city for information about buried lines (telephone, cable TV, water, sewer, gas, etc.).

FIRE PREVENTION



Maintenance

The machine and some attachments have components that are at high temperatures under normal operating conditions. The primary source of high temperatures is the engine and exhaust system. The electrical system, if damaged or incorrectly maintained, can be a source of arcs or sparks.

Flammable debris (leaves, straw, etc.) must be removed regularly. If flammable debris is allowed to accumulate, it can cause a fire hazard. Clean often to avoid this accumulation. Flammable debris in the engine compartment is a potential fire hazard.

The operator's area, engine compartment and engine cooling system must be inspected every day and cleaned if necessary to prevent fire hazards and overheating.

All fuels, most lubricants and some coolants mixtures are flammable. Flammable fluids that are leaking or spilled onto hot surfaces or onto electrical components can cause a fire.

Operation

Do not use the machine where exhaust, arcs, sparks or hot components can contact flammable material, explosive dust or gases.

Electrical



Check all electrical wiring and connections for damage. Keep the battery terminals clean and tight. Repair or replace any damaged part or wires that are loose or frayed.

Battery gas can explode and cause serious injury. Use the procedure in the Operation & Maintenance Manual for connecting the battery and for jump starting. Do not jump start or charge a frozen or damaged battery. Keep any open flames or sparks away from batteries. Do not smoke in battery charging area.

Hydraulic System

Check hydraulic tubes, hoses and fittings for damage and leakage. Never use open flame or bare skin to check for leaks. Hydraulic tubes and hoses must be properly routed and have adequate support and secure clamps. Tighten or replace any parts that show leakage.

Always clean fluid spills. Do not use gasoline or diesel fuel for cleaning parts. Use commercial nonflammable solvents.

Fueling



Stop the engine and let it cool before adding fuel. No smoking! Do not refuel a machine near open flames or sparks. Fill the fuel tank outdoors.

Starting

Do not use ether or starting fluids on any engine that has glow plugs. These starting aids can cause explosion and injure you or bystanders.

Use the procedure in the Operation & Maintenance Manual for connecting the battery and for jump starting.

Spark Arrestor Exhaust System

The spark arrestor exhaust system is designed to control the emission of hot particles from the engine and exhaust system, but the muffler and the exhaust gases are still hot.

Check the spark arrestor exhaust system regularly to make sure it is maintained and working properly. Use the procedure in the Operation & Maintenance Manual for cleaning the spark arrestor muffler (if equipped).

FIRE PREVENTION (CONT'D)

Welding And Grinding

Always clean the machine and attachment, disconnect the battery, and disconnect the wiring from the Bobcat controllers before welding. Cover rubber hoses, battery and all other flammable parts. Keep a fire extinguisher near the machine when welding.

Have good ventilation when grinding or welding painted parts. Wear dust mask when grinding painted parts. Toxic dust or gas can be produced.

Dust generated from repairing nonmetallic parts such as hoods, fenders or covers can be flammable or explosive. Repair such components in a well ventilated area away from open flames or sparks.

Fire Extinguishers

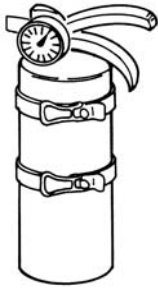

Know where fire extinguishers and first aid kits are located and how to use them. Inspect the fire extinguisher and service the fire extinguisher regularly. Obey the recommendations on the instructions plate.

SERIAL NUMBER LOCATIONS

Always use the serial number of the loader when requesting service information or when ordering parts. Early or later models (identification made by serial number) may use different parts, or it may be necessary to use a different procedure in doing a specific service operation.

Bobcat Loader Serial Number

Figure 1

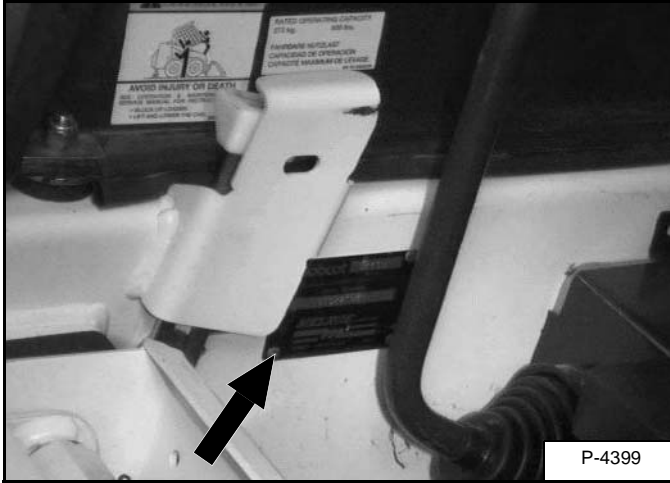

The loader serial number plate is located on the inside of the operator cab on the right fender and in front of the seat [Figure 1].

Explanation of loader Serial Number:

XXXX	XXXXX
Model/ Engine Version	Production Sequence (Series)

Engine Serial Number

Figure 2

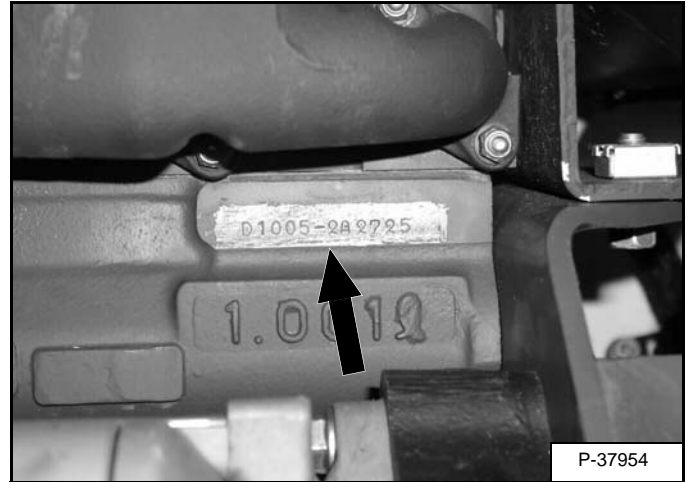

The engine serial number is located on the engine fuel injection pump [Figure 2].

DELIVERY REPORT

Figure 3

The Delivery Report must be filled out by the dealer and signed by the owner or operator when the Bobcat loader is delivered. An explanation of the form must be given to the owner. Make sure it is filled out completely [Figure 3].

BOBCAT LOADER IDENTIFICATION

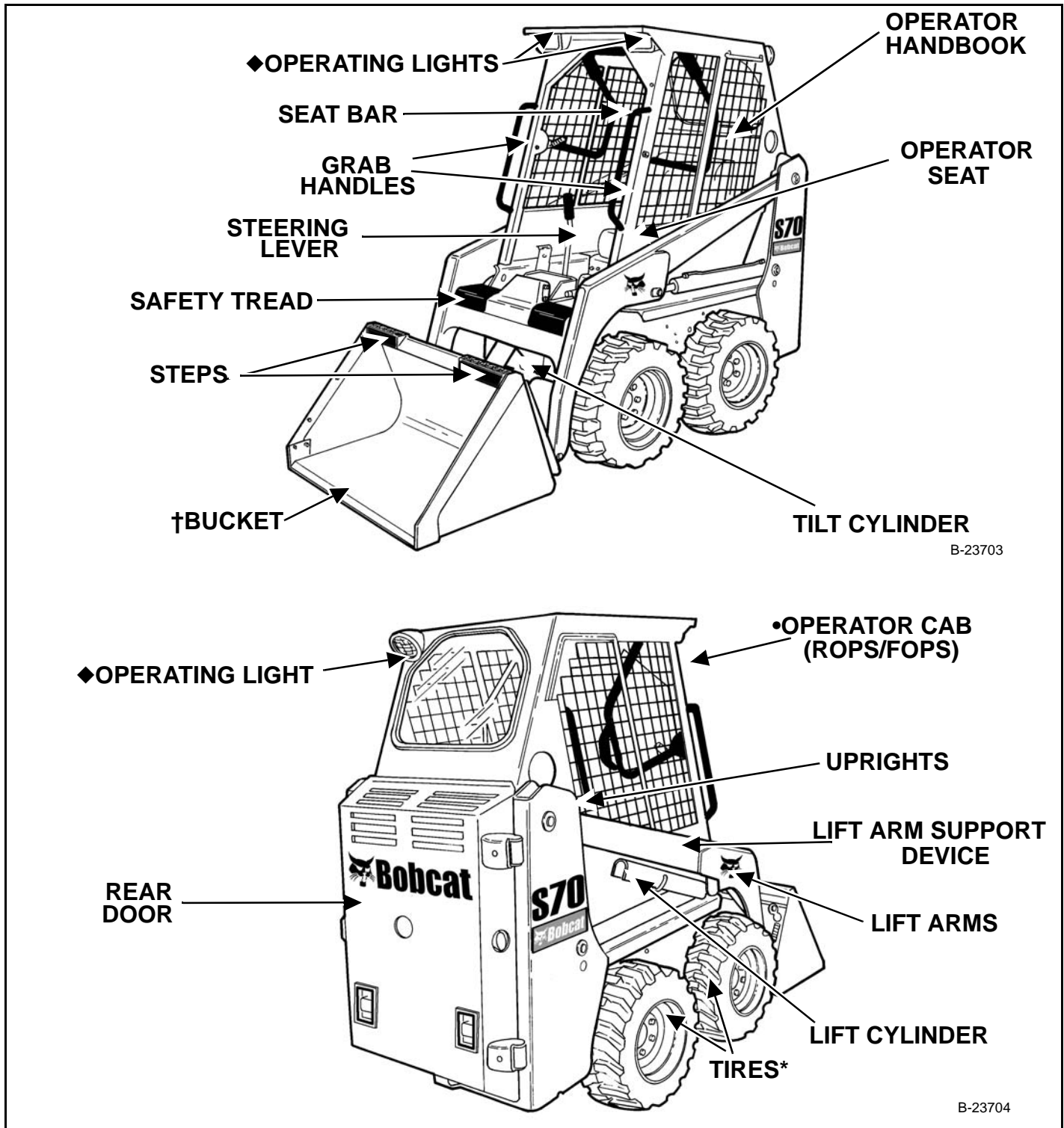

B-23703

B-23704

◆ FACTORY OPTIONAL OR FIELD ACCESSORY (Not Standard Equipment)

* TIRES - Flotation tires (Optional) are shown. bobcats are base-equipped with standard tires.

† BUCKET - Several different buckets and other attachments are available for the Bobcat loader.

● ROPS, FOPS - Roll Over Protective Structure, per SAE J1040 and ISO 3471, and Falling Object Protective Structure per SAEJ1043 and ISO 3449, Level I. Level II is available. The Bobcat loader is base-equipped with a standard operator cab as shown. Extra insulated cab is available as an option (Reduced noise level).

SAFETY AND MAINTENANCE

SAFETY & MAINTENANCE

AIR CLEANER SERVICE	10-80-1
Replacing Filter Elements	10-80-1
AUXILIARY CONTROL LOCKBOLT	10-140-1
Procedure	10-140-1
BOB-TACH	10-150-1
Inspection And Maintenance	10-150-1
ENGINE COOLING SYSTEM	10-90-1
Checking Level	10-90-1
Cleaning	10-90-1
Removing And Replacing Coolant	10-90-2
ENGINE LUBRICATION SYSTEM	10-110-1
Checking And Adding Engine Oil	10-110-1
Engine Oil Chart	10-110-1
Removing And Replacing Oil And Filter	10-110-1
FINAL DRIVE TRANSMISSION (CHAINCASE)	10-130-1
Checking And Adding Oil	10-130-1
Removing And Replacing Oil	10-130-1
FUEL SYSTEM	10-100-1
Filling The Fuel Tank	10-100-1
Fuel Filter	10-100-2
Fuel Specifications	10-100-1
Removing Air From The Fuel System	10-100-2
HYDRAULIC/HYDROSTATIC SYSTEM	10-120-1
Checking And Adding Fluid	10-120-1
Hydraulic / Hydrostatic Fluid Chart	10-120-1
Removing And Replacing Hydraulic / Hydrostatic Filter ..	10-120-2
Removing And Replacing Hydraulic / Hydrostatic Fluid ..	10-120-3
LIFT ARM SUPPORT DEVICE	10-20-1
Installing	10-20-1
Removing	10-20-2
LIFTING AND BLOCKING THE LOADER	10-10-1
Procedure	10-10-1
LOADER STORAGE AND RETURN TO SERVICE	10-210-1
Return To Service	10-210-1
Storage	10-210-1
LUBRICATING THE LOADER	10-160-1
Lubrication Locations	10-160-1

Continued On Next Page

SAFETY AND MAINTENANCE (CONT'D)

OPERATOR CAB	10-30-1
Description	10-30-1
Emergency Exit	10-30-4
Lowering	10-30-2
Raising	10-30-1
PIVOT PINS	10-190-1
Inspection And Maintenance	10-190-1
REMOTE START TOOL-MEL 1563	10-60-1
Remote Start Procedure	10-60-3
Remote Start Tool - MEL1563	10-60-1
Service Tool Harness Communicator - MEL1566	10-60-2
Service Tool Harness Control - MEL1565	10-60-2
REMOTE START TOOL (SERVICE TOOL) KIT -6689779 ...	10-61-1
Computer Service Tool Harness - 6689746	10-61-4
Description	10-61-1
Loader Service Tool Harness - 6689747	10-61-3
Remote Start Procedure	10-61-5
Remote Start Tool (Service Tool) - 6689778	10-61-2
SEAT BAR RESTRAINT SYSTEM	10-200-1
Operation	10-200-1
SERVICE SCHEDULE	10-70-1
Chart	10-70-1
SPARK ARRESTOR MUFFLER	10-180-1
Cleaning Procedure	10-180-1
STOPPING THE ENGINE AND LEAVING THE LOADER ..	10-220-1
Procedure	10-220-1
TIRE MAINTENANCE	10-170-1
Mounting	10-170-1
Rotating	10-170-1
Wheel Nuts	10-170-1
TOWING THE LOADER	10-50-1
Procedure	10-50-1
TRANSPORTING THE LOADER ON A TRAILER	10-40-1
Fastening	10-40-1
Loading And Unloading	10-40-1

TIGHTEN ALL HARDWARE PER SIZE TO GRADE 5 TORQUE (SEE STANDARD TORQUE SPECIFICATIONS FOR BOLTS, SPEC SECTION) UNLESS OTHERWISE SPECIFIED.

LIFTING AND BLOCKING THE LOADER

Procedure

! WARNING

AVOID INJURY OR DEATH

Instructions are necessary before operating or servicing machine. Read and understand the Operation & Maintenance Manual, Operator's Handbook and signs (decals) on machine. Follow warnings and instructions in the manuals when making repairs, adjustments or servicing. Check for correct function after adjustments, repairs or service. Untrained operators and failure to follow instructions can cause injury or death.

W-2003-0807

Figure 10-10-1

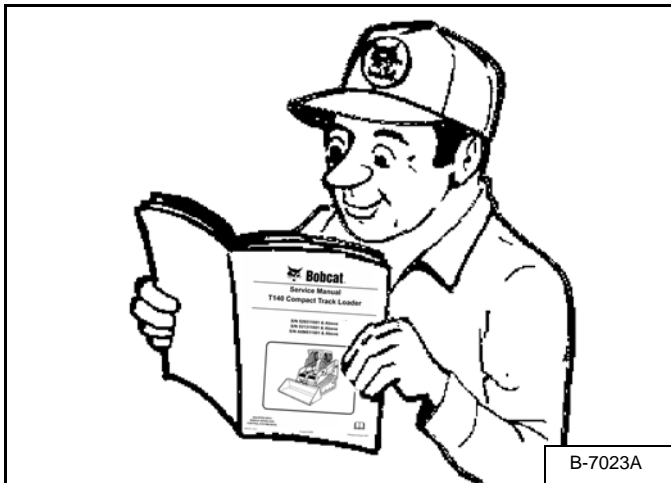

! WARNING

Put jackstands under the front axles and rear corners of the frame before running the engine for service. Failure to use jackstands can allow the machine to fall or move and cause injury or death.

W-2017-0286

Figure 10-10-2



Always park the loader on a level surface.

Put a floor jack under the rear of the loader [Figure 10-10-2].

Lift the rear of the loader and install jackstands [Figure 10-10-2].

Figure 10-10-3

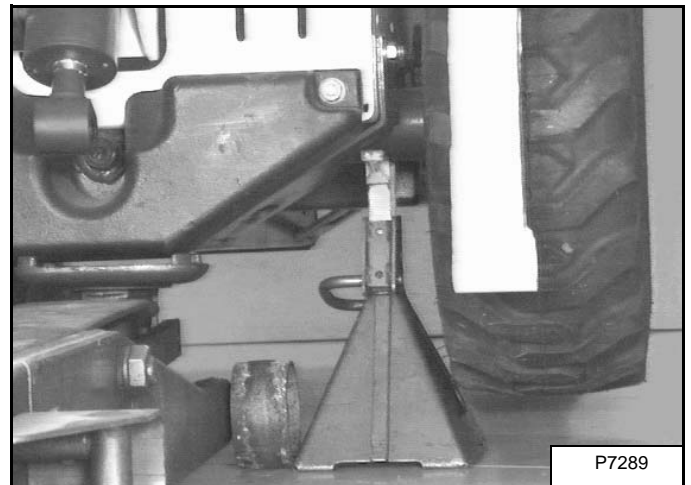

Put the floor jack under the front of the loader [Figure 10-10-3].

Lift the front of the loader and put jackstands under the loader frame.

NOTE: Make sure the jackstands do not touch the tires.



Bobcat®

LIFT ARM SUPPORT DEVICE

Installing

Maintenance and service work can be done with the lift arms lowered. If the lift arms are raised, use the following procedures to engage and disengage an approved lift arm support device.



Never work on a machine with the lift arms up unless the lift arms are secured by an approved lift arm support device. Failure to use an approved lift arm support device can allow the lift arms or attachment to fall and cause injury or death.

W-2059-0598



Repair the support device if damaged or if parts are missing. Using a damaged support device or with missing parts can cause lift arms or boom to fall causing serious injury or death.

W-2271-1007

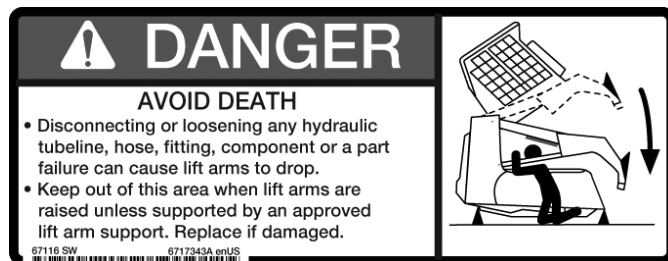
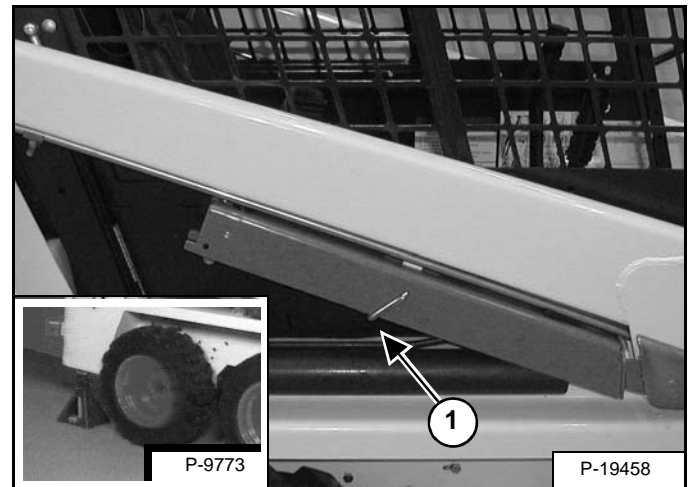

Figure 10-20-1



Put jackstands under the rear corners of the loader frame (Inset) [Figure 10-20-1].

Disconnect the spring from the lift arm support device retaining pin (Item 1) [Figure 10-20-1], hold the support device and remove the retaining pin.

Figure 10-20-2

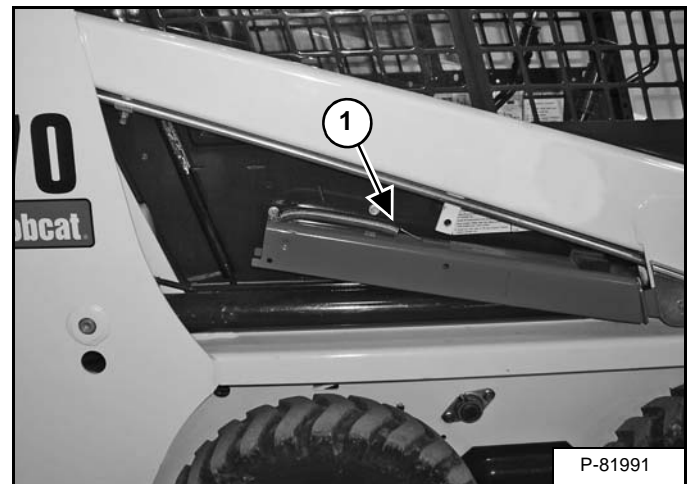

Lower the lift arm support device to the top of the lift cylinder. Fasten the free end of the spring (Item 1) [Figure 10-20-2] to the lift arms support device so there will be no interference with the support device engagement.

With the operator in the seat, seat belt fastened and seat bar lowered, start the engine, press the green PRESS TO OPERATE Button.

LIFT ARM SUPPORT DEVICE (CONT'D)

Installing (Cont'd)

Figure 10-20-3

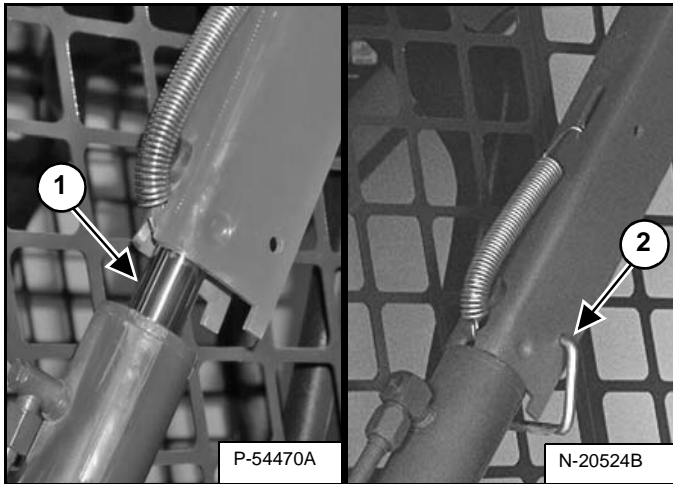

Start the engine and raise the lift arms until the lift arm support device drops onto the lift cylinder rod (Item 1) [Figure 10-20-3].

Lower the lift arms slowly until the support device is held between the lift arm and the lift cylinder. Stop the engine. Raise the seat bar and move both pedals until both pedals lock.

Install pin (Item 2) [Figure 10-20-3] into the rear of the lift arm support device below the cylinder rod.

Removing

Figure 10-20-4

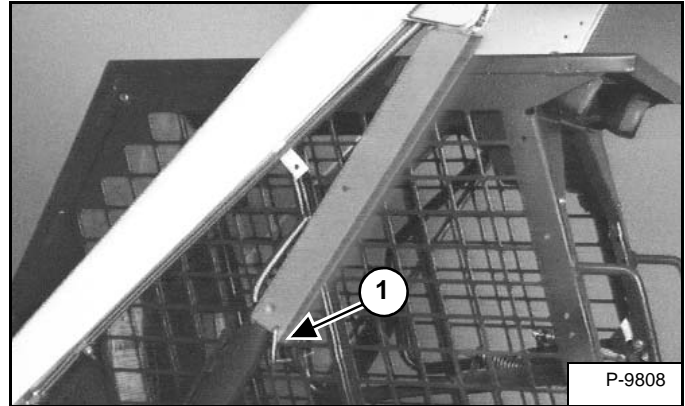

Remove the retaining pin (Item 1) [Figure 10-20-4] from the lift arm support device.

Figure 10-20-5

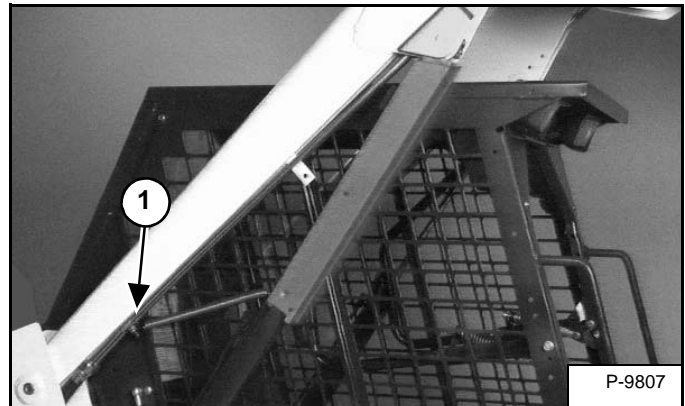

Connect the spring from the lift arm support device to the tubeline bracket (Item 1) [Figure 10-20-5] on the lift arms.

With the operator in the seat, seat belt fastened and seat bar lowered, start the engine, press the green PRESS TO OPERATE Button.

Raise the lift arms a small amount. The spring will lift the support device off the lift cylinder rod.

Lower the lift arms and stop the engine.

Raise the seat bar, disconnect the seat belt and move the pedals until both pedals lock.

Disconnect the spring from the bracket.

LIFT ARM SUPPORT DEVICE (CONT'D)

Removing (Cont'd)

Figure 10-20-6

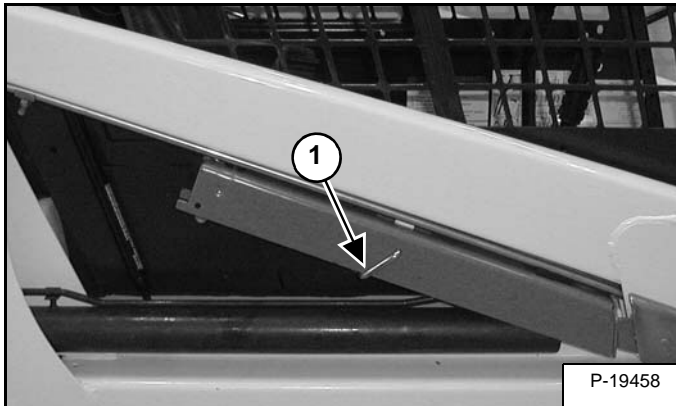

Raise the support device into storage position and insert the pin through the lift arm support device and bracket (Item 1) [Figure 10-20-6].

Connect the spring to the pin [Figure 10-20-6]

Remove the jackstands.



Bobcat®

OPERATOR CAB

Description

The Bobcat Loader has an operator cab (ROPS and FOPS) as standard equipment to protect the operator from rollover and falling objects. Check with your dealer if the operator cab has been damaged. The seat belt must be worn for rollover protection.

ROPS / FOPS - Roll Over Protective Structure per ISO 3471, and Falling Object Protective Structure per ISO 3449, Level I.

Level I - Protection from falling bricks, small concrete blocks, and hand tools encountered in operations such as highway maintenance, landscaping, and other construction sites.



Never modify operator cab by welding, grinding, drilling holes or adding attachments unless instructed to do so by Bobcat Company. Changes to the cab can cause loss of operator protection from rollover and falling objects, and result in injury or death.

W-2069-0200

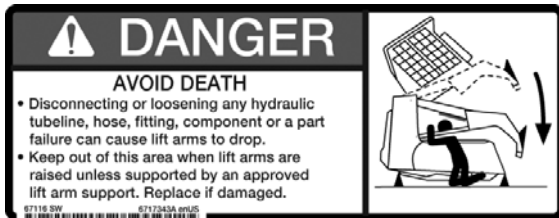

Raising

Always stop the engine before raising or lowering the cab.

Stop the loader on a level surface and lower the lift arms. If the lift arms must be up while raising the operator cab, install the lift arm support device. (See LIFT ARM SUPPORT DEVICE on Page 10-20-1.)

Figure 10-30-1

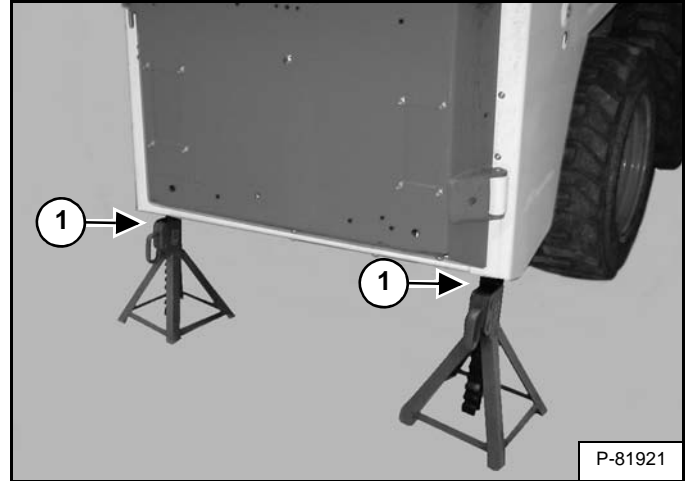

Install jackstands (Item 1) [Figure 10-30-1] under the rear corners of the loader frame.

Figure 10-30-2

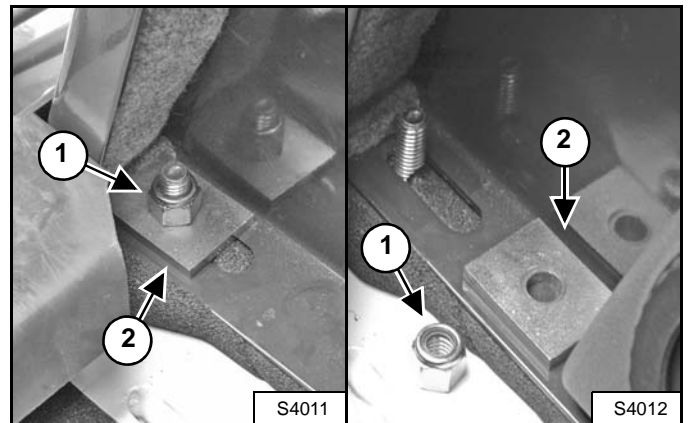

Remove the nut and plate (Items 1&2) [Figure 10-30-2] on the inside front corner of the cab (Both sides).

OPERATOR CAB (CONT'D)

Raising (Cont'd)

Figure 10-30-3



Lift on the grab handle and bottom of the operator cab slowly until the cab is all the way up and the latching mechanism engages [Figure 10-30-3].

Lowering

! WARNING

AVOID INJURY OR DEATH

The cab must be held to prevent falling while hand is in access hole.

W-2205-1207

Always stop the engine before raising or lowering the cab.

Figure 10-30-4

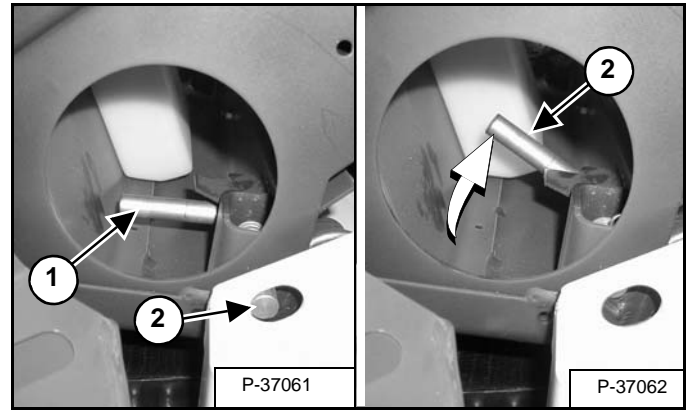

Hold the operator cab. Release the locking mechanism by pushing the lever (Item 1) in from the locked position (Item 2) and turning the lever until it stays in the unlocked position (Item 3) [Figure 10-30-4].

REMOVE YOUR HAND FROM THE HOLE BEFORE LOWERING THE OPERATOR CAB.

Stand on the ground and pull the cab down. Avoid slippery surfaces.

NOTE: The weight of the cab increases when equipped with options and accessories such as cab door, heater, air conditioning, etc. In these cases, the cab may need to be raised slightly from the latch to be able to release the latch.

NOTE: Always use the grab handles (once you can reach them) to lower the cab.

Figure 10-30-5

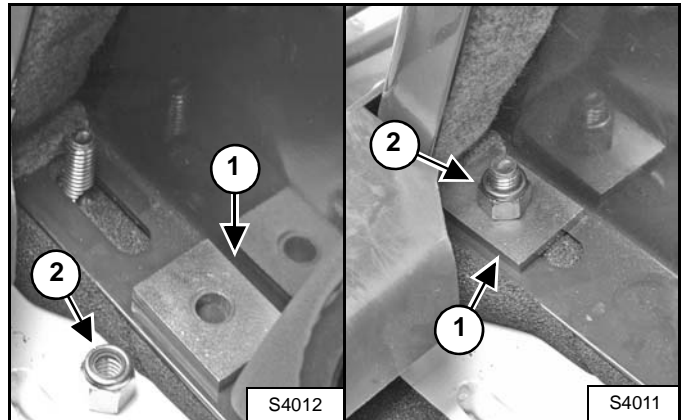

Install the plates and nuts (Items 1&2) [Figure 10-30-5] (both sides).

Tighten the nuts to 40-45 ft.-lb. (54-61 N•m) torque.

OPERATOR CAB (CONT'D)

Lowering (Cont'd)

If equipped with a heater, do the following:

NOTE: The heater hose connectors will disconnect when the cab is raised. The heater hose connectors must be reconnected for the heater to work after the cab is lowered and secured.

Move the seat as far forward as needed to access the heater hose connectors that are located at the rear of the cab.

Figure 10-30-6

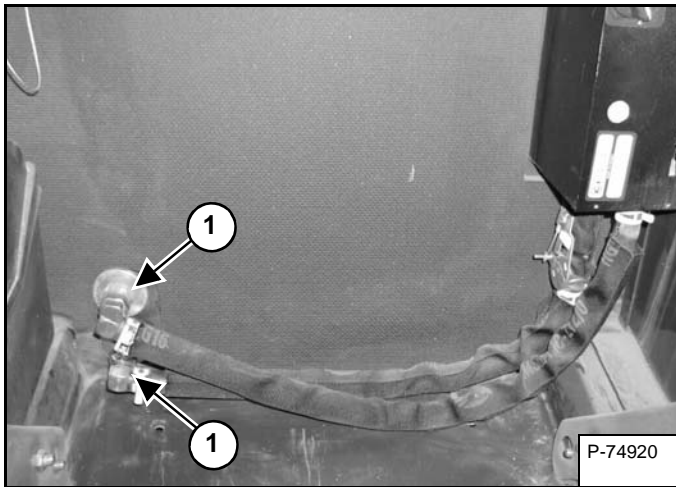

From behind the operator's seat, push the two heater quick connectors (Item 1) [Figure 10-30-6] into the heater couplers.

OPERATOR CAB (CONT'D)

Emergency Exit

The front opening on the operator cab and rear window provide exits.

Rear Window (If Equipped)

Figure 10-30-7

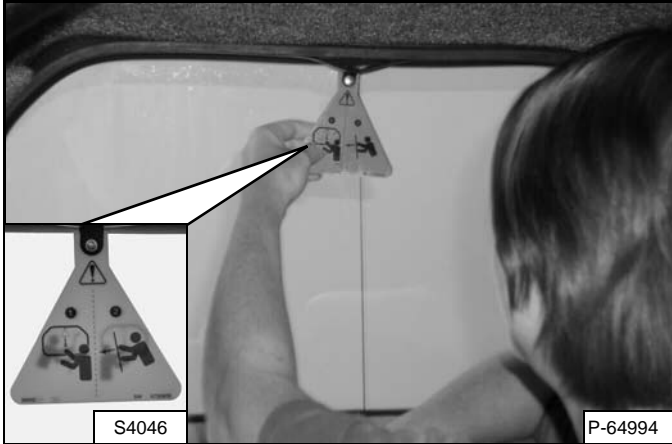

Pull on the tag (Item 1) [Figure 10-30-7] at the top of the rear window to remove the rubber cord.

Push the rear window out of the rear of the operator cab.

Figure 10-30-8



Exit through the rear of the cab [Figure 10-30-8].

Front Door (If Equipped)

NOTE: When an Operator Cab Enclosure Kit is installed, the window of the front door can be used as an emergency exit [Figure 10-30-9].

NOTE: If the loader has a special Application Door Kit installed, the window of the front door is NOT an emergency exit.

Figure 10-30-9

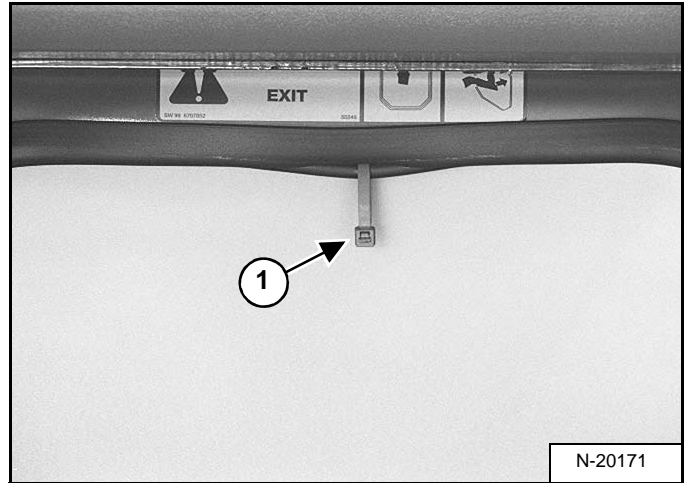

Pull the plastic loop (Item 1) [Figure 10-30-9] at the top of the window in the front door to remove the rubber cord.

Figure 10-30-10

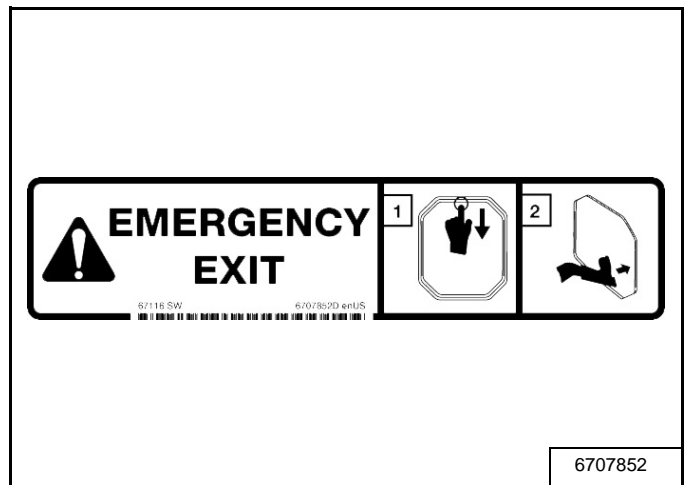

Push the window out with your foot at any corner of the window (Item 2) [Figure 10-30-10].

Exit through the door.

TRANSPORTING THE LOADER ON A TRAILER

Loading And Unloading



AVOID SERIOUS INJURY OR DEATH

Adequately designed ramps of sufficient strength are needed to support the weight of the machine when loading onto a transport vehicle. Wood ramps can break and cause personal injury.

W-2058-0807

Be sure the transport and towing vehicles are of adequate size and capacity for the weight of the loader.

Figure 10-40-1

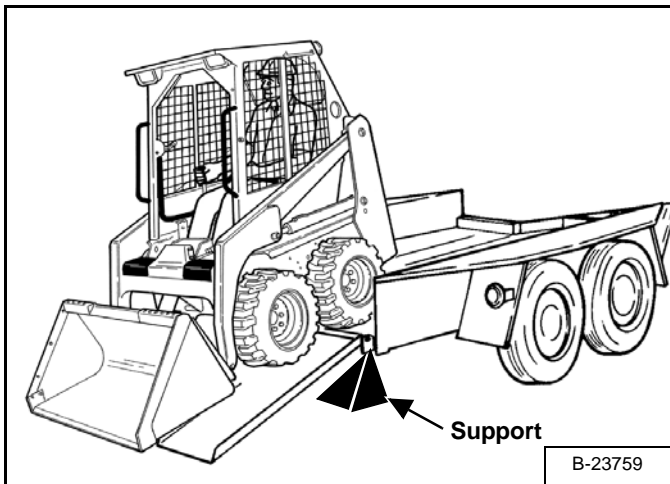

A loader with an empty bucket or no attachment must be loaded backward onto the transport vehicle [Figure 10-40-1].

The rear of the trailer must be blocked or supported [Figure 10-40-1] when loading or unloading the loader to prevent the front end of the trailer from raising up.

Fastening

Figure 10-40-2

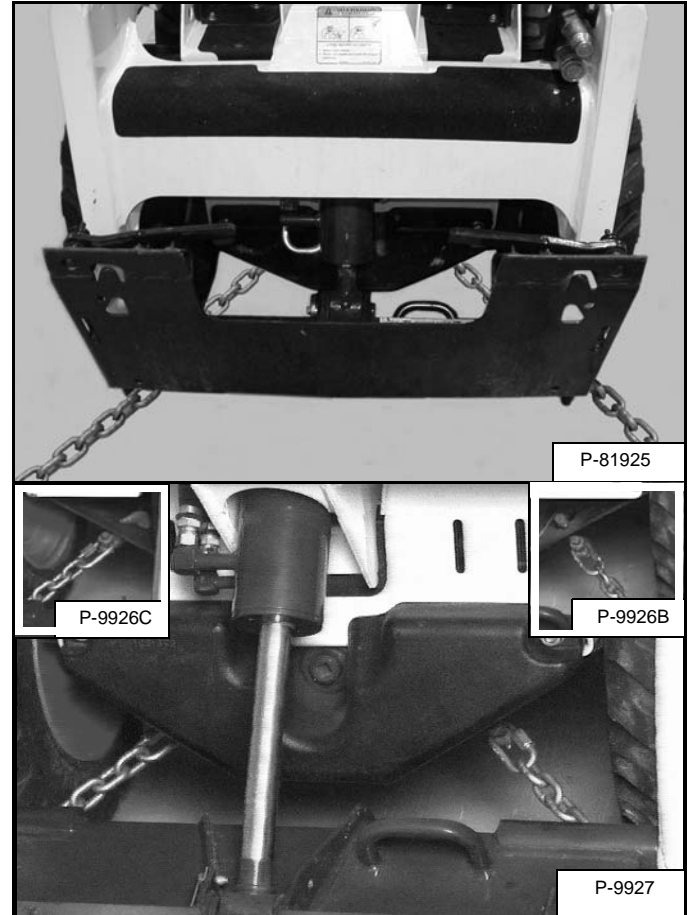

Use the following procedure to fasten the Bobcat Loader to the transport vehicle to prevent the loader from moving during sudden stops or when going up or down slopes [Figure 10-40-2].

- Lower the bucket or attachment to the floor.
- Stop the engine.
- Engage the parking brake.
- Install chains at the front and rear loader tie down positions [Figure 10-40-2].
- Fasten each end of the chain to the transport vehicle.

Figure 10-40-3

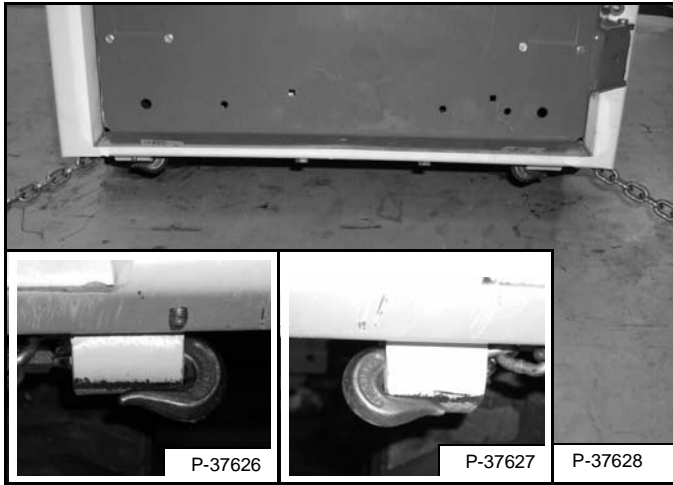

Fasten the rear of the loader as shown [Figure 10-40-3].