

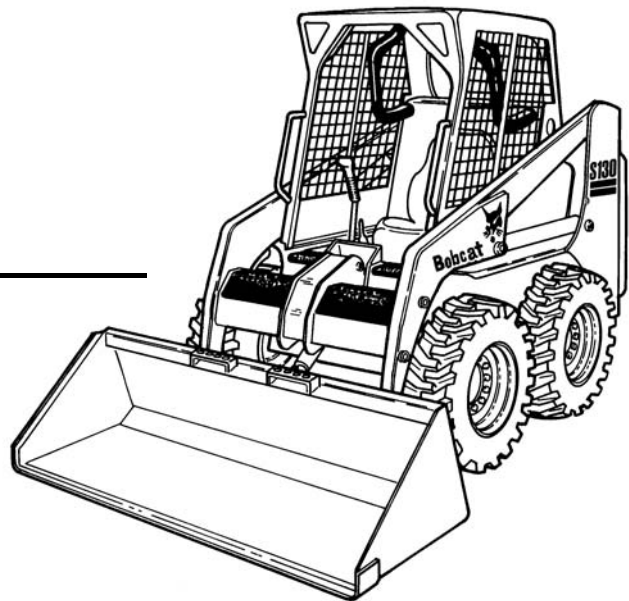

Bobcat®

Service Manual

S/N 524611001 & Above
S/N 524711001 & Above



EQUIPPED WITH
BOBCAT INTERLOCK

CONTROL SYSTEM (BICS™) pages at:

<https://www.aresairmanual.com/downloads/bobcat-s130-skid-steer-loader-service-repair-workshop-manual-524611001-524711001/>

Product: Bobcat S130 Skid Steer Loader Service Repair Workshop Manual 524611001-524711001

Full Download: [https://www.arepairmanual.com/downloads/bobcat-s130-skid-ste](https://www.arepairmanual.com/downloads/bobcat-s130-skid-steer-loader-service-repair-workshop-manual-524611001-524711001)

[er-loader-service-repair-workshop-manual-524611001-524711001](https://www.arepairmanual.com/downloads/bobcat-s130-skid-steer-loader-service-repair-workshop-manual-524611001-524711001)

/

Sample of manual. Download All 636 pages at:

<https://www.arepairmanual.com/downloads/bobcat-s130-skid-steer-loader-service-repair-workshop-manual-524611001-524711001>

MAINTENANCE SAFETY



WARNING

Instructions are necessary before operating or servicing machine. Read and understand the Operation & Maintenance Manual, Operator's Handbook and signs (decals) on machine. Follow warnings and instructions in the manuals when making repairs, adjustments or servicing. Check for correct function after adjustments, repairs or service. Untrained operators and failure to follow instructions can cause injury or death.

W-2003-0903



Safety Alert Symbol: This symbol with a warning statement, means: "Warning, be alert! Your safety is involved!" Carefully read the message that follows.

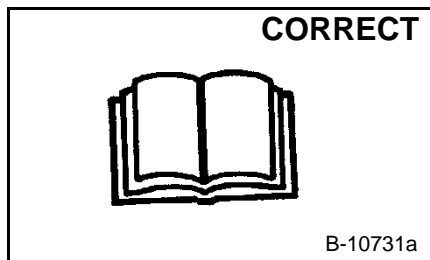

Never service the Bobcat Skid-Steer Loader without instructions.

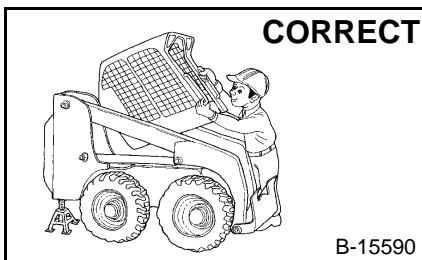

Use the correct procedure to lift or lower operator cab.

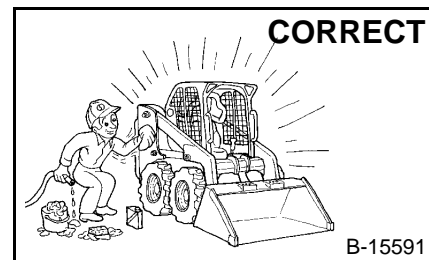

Cleaning and maintenance are required daily.

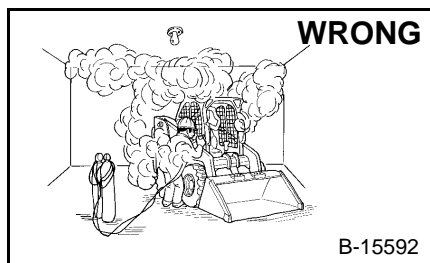

Have good ventilation when welding or grinding painted parts.

Wear dust mask when grinding painted parts. Toxic dust and gas can be produced.

Avoid exhaust fume leaks which can kill without warning. Exhaust system must be tightly sealed.

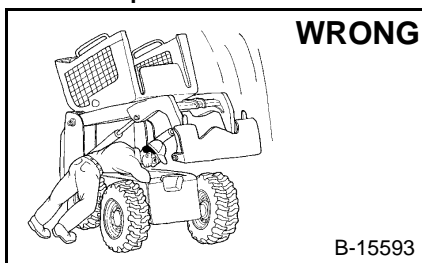

Disconnecting or loosening any hydraulic tubeline, hose, fitting, component or a part failure can cause lift arms to drop. Do not go under lift arms when raised unless supported by an approved lift arm support device. Replace it if damaged.

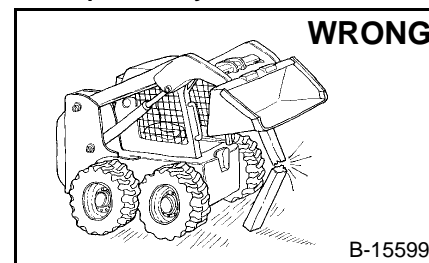

Never work on loader with lift arms up unless lift arms are held by an approved lift arm support device. Replace if damaged.

Never modify equipment or add attachments not approved by Bobcat Company.

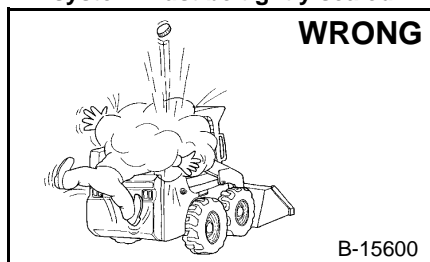

Stop, cool and clean engine of flammable materials before checking fluids.

Never service or adjust loader with the engine running unless instructed to do so in the manual.

Avoid contact with leaking hydraulic fluid or diesel fuel under pressure. It can penetrate the skin or eyes.

Never fill fuel tank with engine running, while smoking or when near open flame.

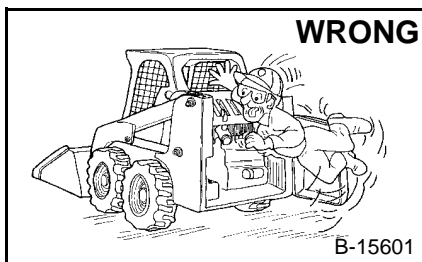

Keep body, jewelry and clothing away from moving parts, electrical contact, hot parts and exhaust.

Wear eye protection to guard from battery acid, compressed springs, fluids under pressure and flying debris when engines are running or tools are used. Use eye protection approved for type of welding.

Keep rear door closed except for service. Close and latch door before operating the loader.

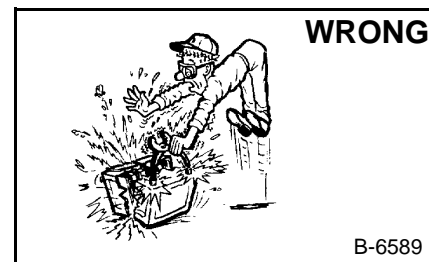

Lead-acid batteries produce flammable and explosive gases.

Keep arcs, sparks, flames and lighted tobacco away from batteries.

Batteries contain acid which burns eyes or skin on contact. Wear protective clothing. If acid contacts body, flush well with water. For eye contact flush well and get immediate medical attention.

Maintenance procedures which are given in the Operation & Maintenance Manual can be performed by the owner/operator without any specific technical training. Maintenance procedures which are **not** in the Operation & Maintenance Manual must be performed **ONLY BY QUALIFIED BOBCAT SERVICE PERSONNEL**. Always use genuine Bobcat replacement parts. The Service Safety Training Course is available from your Bobcat dealer.



Bobcat®

ALPHABETICAL INDEX

| | | | |
|--|--------------|---|--------------|
| ADVANCED CONTROL SYSTEM (ACS) | | FAN GEARBOX..... | 10-01 |
| ADVANCE HAND CONTROL | 60-01 | FINAL DRIVE TRANSMISSION (CHAINCASE)..... | 10-01 |
| ADVANCED CONTROL SYSTEM (ACS) | | FLYWHEEL AND HOUSING | 70-01 |
| SELECTRABLE HAND/FOOT CONTROL..... | 60-01 | FRONT AUXILIARY HYDRAULIC | |
| ADVANCED HAND CONTROL (AHC) SYSTEM.... | 60-01 | COUPLER BLOCK | 20-01 |
| ADVANCED HAND CONTROL (AHC) | | FRONT AUXILIARY PRESSURE | |
| SYSTEM (W/PUSH BUTTON FLOAT) | 60-01 | RELIEF BLOCK..... | 20-01 |
| AIR CLEANER SERVICE | 10-01, 70-01 | FUEL SYSTEM..... | 10-01 |
| | | FUEL TANK..... | 50-01 |
| | | | |
| BASIC TROUBLESHOOTING | 80-01 | HEATER UNIT..... | 80-01 |
| BATTERY | 60-01 | HEATER COIL..... | 80-01 |
| BICS™ SYSTEM | 60-01 | HEATER FAN | 80-01 |
| BOBCAT CONTROLLER | 60-01 | HEATER VALVE | 80-01 |
| BOBCAT INTERLOCK | | HYDRAULIC CONNECTION SPECS | SPEC-01 |
| CONTROL SYSTEM (BICS™) | 60-01 | HYDRAULIC CONTROL VALVE (ADVANCED | |
| BOB-TACH | 10-01, 50-01 | CONTROL SYSTEM) (ACS) | 20-01 |
| BRAKE..... | 40-01 | HYDRAULIC CONTROL VALVE | |
| BUCKET POSITION VALVE..... | 20-01 | (FOOT CONTROL)..... | 20-01 |
| | | HYDRAULIC FLUID RESERVOIR | 20-01 |
| | | HYDRAULIC/HYDROSTATIC FILTER..... | 20-01 |
| CHAINCASE | 40-01 | HYDRAULIC FLUID SPECIFICATIONS | SPEC-01 |
| CHARGE PRESSURE | 30-01 | HYDRAULIC/HYDROSTATIC SYSTEM | 10-01 |
| COMPONENTS | 80-01 | HYDRAULIC SYSTEM INFORMATION | 20-01 |
| CONTROL HANDLE | 50-01 | HYDRAULIC PUMP | 20-01 |
| CONTROL HANDLE | | HYDROSTATIC MOTOR | 30-01 |
| (ADVANCE HAND CONTROL) (AHC)..... | 50-01 | HYDROSTATIC PUMP | 30-01 |
| CONTROL HANDLE (ADVANCED CONTROL SYSTEM) | | HYDROSTATIC SYSTEM INFORMATION..... | 30-01 |
| (ACS) ADVANCED HAND CONTROL..... | 50-01 | | |
| CONTROL PANEL..... | 50-01 | INSTRUMENT PANEL | 60-01 |
| CONTROL PEDALS | 50-01 | | |
| CONTROL PEDALS (ACS) | 50-01 | LIFT ARM | 50-01 |
| CONVERSIONS | SPEC-01 | LIFT ARM BY-PASS CONTROL VALVE | 20-01 |
| COOLING FAN | 70-01 | LIFT ARM SUPPORT DEVICE | 10-01 |
| CYLINDER (LIFT)..... | 20-01 | LIFTING AND BLOCKING THE LOADER..... | 10-01 |
| CYLINDER (POWER BOB-TACH) | 20-01 | LIGHTS..... | 60-01 |
| CYLINDER (TILT)..... | 20-01 | LOADER SPECIFICATIONS..... | SPEC-01 |
| | | LUBRICATION OF THE BOBCAT LOADER..... | 10-01 |
| | | | |
| DIAGNOSTICS | 60-01 | MAIN RELIEF VALVE | 20-01 |
| DRIVE BELT | 30-01 | MUFFLER..... | 70-01 |
| DRIVE COMPONENTS | 40-01 | | |
| | | OIL COOLER..... | 30-01 |
| ELECTRICAL/HYD. CONTROLS REFERENCE | 60-01 | OPERATOR CAB | 10-01, 50-01 |
| ELECTRICAL SYSTEM INFORMATION..... | 60-01 | OPERATOR SEAT | 50-01 |
| ENGINE | 70-01 | OPERATOR SEAT (SUSPENSION) | 50-01 |
| ENGINE COMPONENTS AND TESTING | 70-01 | | |
| ENGINE COOLING SYSTEM..... | 10-01 | POWER BOB-TACH | 50-01 |
| ENGINE LUBRICATION SYSTEM | 10-01 | POWER BOB-TACH BLOCK | 50-01 |
| ENGINE SPECIFICATIONS..... | SPEC- | | |
| ENGINE SPEED CONTROL | 70-01 | | |

Continued On Next Page

ALPHABETICAL INDEX (CONT'D)

| | |
|---------------------------------------|---------|
| RADIATOR..... | 70- |
| REAR DOOR | 50-01 |
| REAR GRILL | 50-01 |
| RECONDITIONING THE ENGINE | 70-01 |
| REGULAR MAINTENANCE | 80-01 |
| REMOTE START..... | 10-01 |
| RPM SENSOR..... | 70-01 |
| | |
| SEAT BAR..... | 50-01 |
| SEAT BAR SENSOR..... | 60-01 |
| SELECT VALVE | 20- |
| SERVICE SCHEDULE..... | 10-01 |
| SPARK ARRESTOR MUFFLER..... | 10-01 |
| STARTER | 60-01 |
| SYSTEM TROUBLESHOOTING CHART | 80-01 |
| | |
| TIRE MAINTENANCE..... | 10-01 |
| TORQUE SPECIFICATIONS FOR BOLTS | SPEC-01 |
| TOWING THE LOADER | 10-01 |
| TRACTION LOCK..... | 60-01 |
| TRANSPORTING THE LOADER | 10-01 |
| TROUBLESHOOTING..... | 70-01 |

CONTENTS

**SAFETY &
MAINTENANCE**

**HYDRAULIC
SYSTEM**

**HYDROSTATIC
SYSTEM**

**DRIVE
SYSTEM**

MAIN FRAME

**ELECTRICAL
SYSTEM &
ANALYSIS**

**ENGINE
SERVICE**

HEATER

SPECIFICATIONS

| | |
|------------------------------------|---------|
| FOREWORD..... | II |
| SAFETY INSTRUCTIONS | V |
| SERIAL NUMBER LOCATIONS | IX |
| DELIVERY REPORT..... | X |
| LOADER IDENTIFICATION | XI |
| SAFETY AND MAINTENANCE..... | 10-01 |
| HYDRAULIC SYSTEM | 20-01 |
| HYDROSTATIC SYSTEM..... | 30-01 |
| DRIVE SYSTEM | 40-01 |
| MAIN FRAME | 50-01 |
| ELECTRICAL SYSTEM & ANALYSIS | 60-01 |
| ENGINE SERVICE | 70-01 |
| HEATER | 80-01 |
| SPECIFICATIONS | SPEC-01 |

FOREWORD

This manual is for the Bobcat loader mechanic. It provides necessary servicing and adjustment procedures for the Bobcat loader and its component parts and systems. Refer to the Operation & Maintenance Manual for operating instructions, starting procedure, daily checks, etc.

A general inspection of the following items must be made after the loader has had service or repair:

1. Check that the ROPS/FOPS (Including side screens) is in good condition and is not modified.

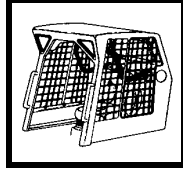

2. Check that ROPS mounting hardware is tightened and is Bobcat approved.



3. The seat belt must be correctly installed, functional and in good condition.

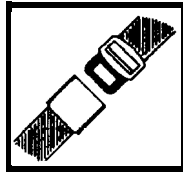

4. The seat bar must be correctly adjusted, clean and lubricated.

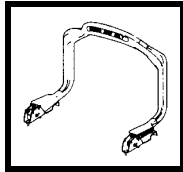

5. Check lift arm support device, replace if damaged.

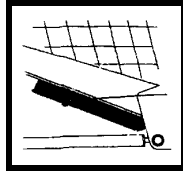

6. Machine signs must be legible and in the correct location.



7. Steering levers and foot pedals must return to neutral.

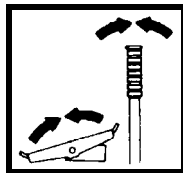

8. Check for correct function of the work lights



9. The parking brake must function correctly.

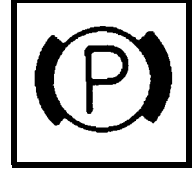

10. Enclosure door latches must open and close freely.

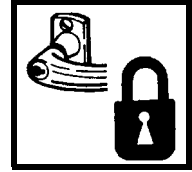

11. Bob-Tach wedges and linkages must function correctly and be in good condition.

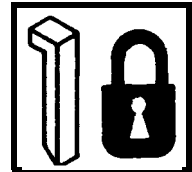

12. Safety treads must be in good condition.

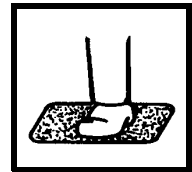

13. Check for correct function of indicator lamps (Optional on some models).

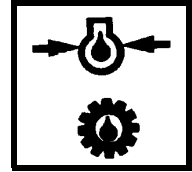

14. Check hydraulic fluid level, engine oil level and fuel supply.

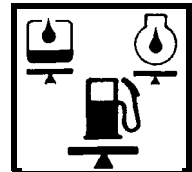

15. Inspect for fuel, oil or hydraulic fluid leaks.

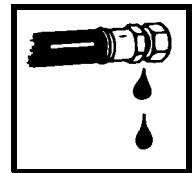

16. Lubricate the loader.

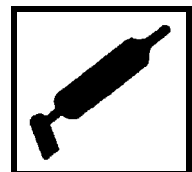

17. Check the condition of the battery and cables.

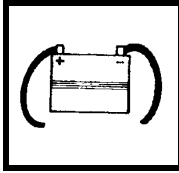

22. Operate the loader and check all functions.

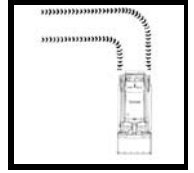

18. Inspect the air cleaner for damage or leaks. Check the condition of the element.

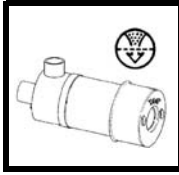

23. Check for any field modification not completed.



19. Check the electrical charging system.

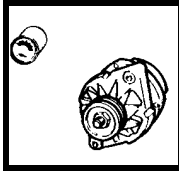

24. Check for correct function of the Bobcat Interlock Control System (BICS™) before the machine is returned to the customer.

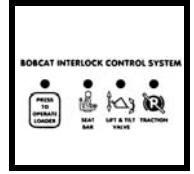

20. Check tires for wear and pressure.

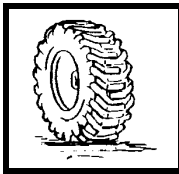

Recommend to the owner that all necessary corrections be made before the machine is returned to service.

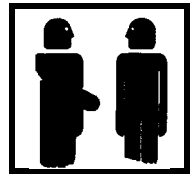

21. Inspect for loose or broken parts or connections.

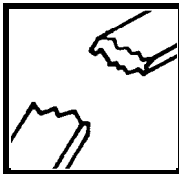

**CALIFORNIA
PROPOSITION 65 WARNING**
Diesel engine exhaust and some of its constituents are known to the State of California to cause cancer, birth defects and other reproductive harm.



Bobcat®

SAFETY INSTRUCTIONS



Safety Alert Symbol

This symbol with a warning statement means:
“Warning, be alert! Your safety is involved!”
Carefully read the message that follows.



WARNING

Instructions are necessary before operating or servicing machine. Read and understand the Operation & Maintenance Manual, Operator's Handbook and signs (decals) on machine. Follow warnings and instructions in the manuals when making repairs, adjustments or servicing. Check for correct function after adjustments, repairs or service. Untrained operators and failure to follow instructions can cause injury or death.

W-2003-0903



WARNING

Warnings on the machine and in the manuals are for your safety. Failure to obey warnings can cause injury or death.

W-2044-1285

IMPORTANT

This notice identifies procedures which must be followed to avoid damage to the machine.

I-2019-0284

The following publications provide information on the safe use and maintenance of the Bobcat machine and attachments:

- The Delivery Report is used to assure that complete instructions have been given to the new owner and that the machine is in safe operating condition.
- The Operation & Maintenance Manual delivered with the machine or attachment contains operating information as well as routine maintenance and service procedures. It is a part of the machine and can be stored in a container provided on the machine. Replacement Operation & Maintenance Manuals can be ordered from your Bobcat dealer.
- Machine signs (decals) instruct on the safe operation and care of your Bobcat machine or attachment. The signs and their locations are shown in the Operation & Maintenance Manual. Replacement signs are available from your Bobcat dealer.
- An Operator's Handbook fastened to the operator cab. It's brief instructions are convenient to the operator. The handbook is available from your dealer in an English edition or one of many other languages. See your Bobcat dealer for more information on translated versions.
- The AEM Safety Manual delivered with the machine gives general safety information.
- The Service Manual and Parts Manual are available from your dealer for use by mechanics to do shop-type service and repair work.
- The Skid-Steer Loader Operator Training Course is available through your local dealer or at www.training.bobcat.com or www.bobcat.com. This course is intended to provide rules and practices of correct operation of the Skid-Steer Loader. The course is available in English and Spanish versions.
- Service Safety Training Courses are available from your Bobcat dealer or at www.training.bobcat.com or www.bobcat.com. They provide information for safe and correct service procedures.
- The Skid-Steer Loader Safety Video is available from your Bobcat dealer or at www.training.bobcat.com or www.bobcat.com.

SI SSL-0206 SM

SAFETY INSTRUCTIONS (CONT'D)

The dealer and owner/operator review the recommended uses of the product when delivered. If the owner/operator will be using the machine for a different application(s) he or she must ask the dealer for recommendations on the new use.



Call Before You Dig

1-888-258-0808

When you call, you will be directed to a location in your state/city for information about buried lines (telephone, cable TV, water, sewer, gas, etc.)

SAFETY INSTRUCTIONS (CONT'D)

Fire Prevention

The machine and attachments have components that are at high temperature under normal operating conditions. The primary source of high temperatures is the engine and exhaust system. The electrical system, if damaged or incorrectly maintained, can be a source of arcs or sparks.

Flammable debris (leaves, straw, etc.) must be removed regularly. If flammable debris is allowed to accumulate, it will increase fire hazard. Clean often to avoid this accumulation. Flammable debris in the engine compartment is a potential hazard.

The spark arrestor muffler is designed to control the emission of hot particles from the engine and exhaust system, but the muffler and the exhaust gases are still hot.

- Do not use the machine where exhaust, arcs, sparks or hot components can contact flammable material, explosive dust or gases.
- The operator cab, engine compartment, and engine cooling system must be inspected every day and cleaned if necessary to prevent fire hazard and overheating.
- Check all electrical wiring and connections for damage. Keep the battery terminals clean and tight. Repair or replace any damaged part.
- Check fuel and hydraulic tubes, hoses and fittings for damage and leakage. Never use open flame or bare skin to check for leaks. Tighten or replace any parts that show leakage. Always clean fluid spills. Do not use gasoline or diesel fuel for cleaning parts. Use commercial nonflammable solvents.
- Do not use ether or starting fluids on any engine which has glow plugs. These starting aids can cause explosion and injure you or bystanders.
- Always clean the machine, disconnect the battery, and disconnect the wiring from the controllers before welding. Cover rubber hoses, battery and all other flammable parts. Keep a fire extinguisher near the machine when welding. Have good ventilation when grinding or welding painted parts. Wear a dust mask when grinding painted parts. Toxic dust or gas can be produced.
- Stop the engine and let it cool before adding fuel. **NO SMOKING!**

- Use the procedure in the Operation & Maintenance Manual for connecting the battery and for jump starting.
- Use the procedure in the Operation & Maintenance Manual for cleaning the spark arrestor muffler (if equipped).

Figure 1

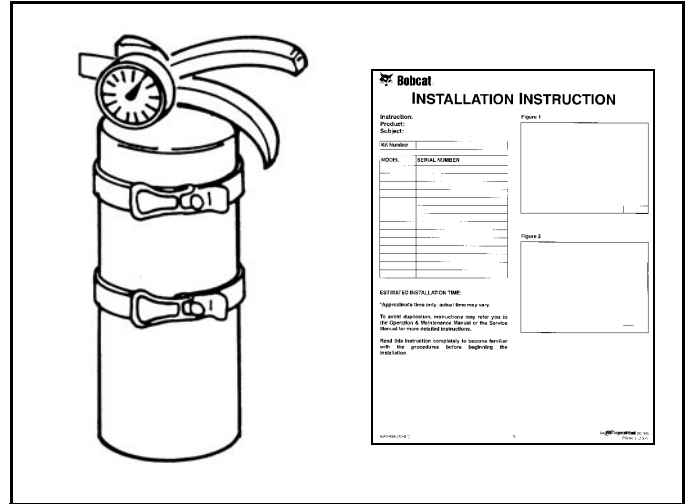

- Know where fire extinguishers and first aid kits are located and how to use them. Fire extinguishers are available from your Bobcat dealer [Figure 1].



Bobcat®

SERIAL NUMBER LOCATIONS

Always use the serial number of the loader when requesting service information or when ordering parts. Early or later models (identification made by serial number) may use different parts, or it may be necessary to use a different procedure in doing a specific service operation.

Loader Serial Number

Figure 2

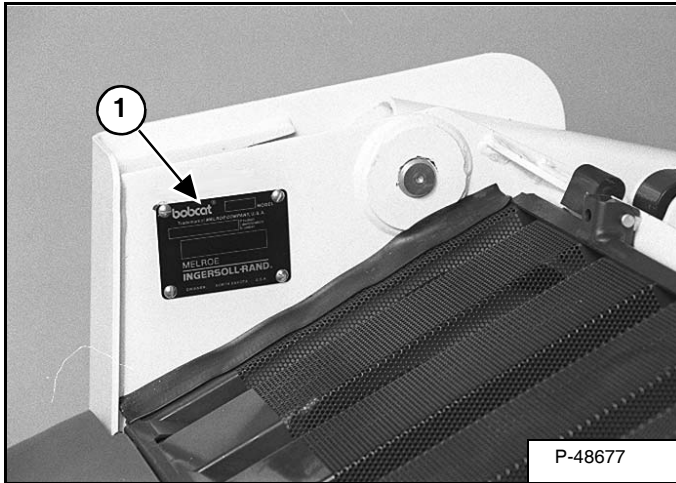

The loader serial number plate is located on the outside of the loader frame [Figure 2].

Explanation of loader Serial Number:

| XXXX | XXXXX |
|------------------------------------|---------------------------------------|
| Model 1.-Model/ Engine Combination | Model 2.-Production Sequence (Series) |

1. The four digit Model/Engine Combination Module number identifies the model number and engine combination.
2. The five digit Production Sequence Number identifies the order which the loader is produced.

Engine Serial Number

Figure 3

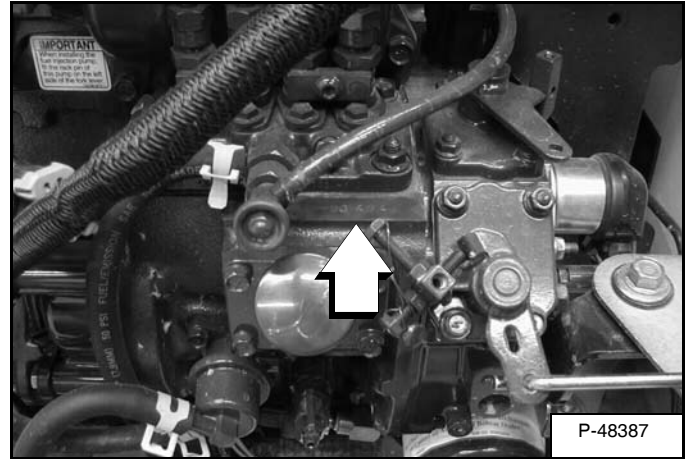

The engine serial number is in the location shown [Figure 3].

DELIVERY REPORT

Figure 4

The diagram shows a form layout for a delivery report. It includes a title 'DELIVERY REPORT', a 'WARNING' section, and a reference code 'B-16315'.

The Delivery Report must be filled out by the dealer and signed by the owner or operator when the Bobcat loader is delivered. An explanation of the form must be given to the owner. Make sure it is filled out completely **[Figure 4]**.

LOADER IDENTIFICATION

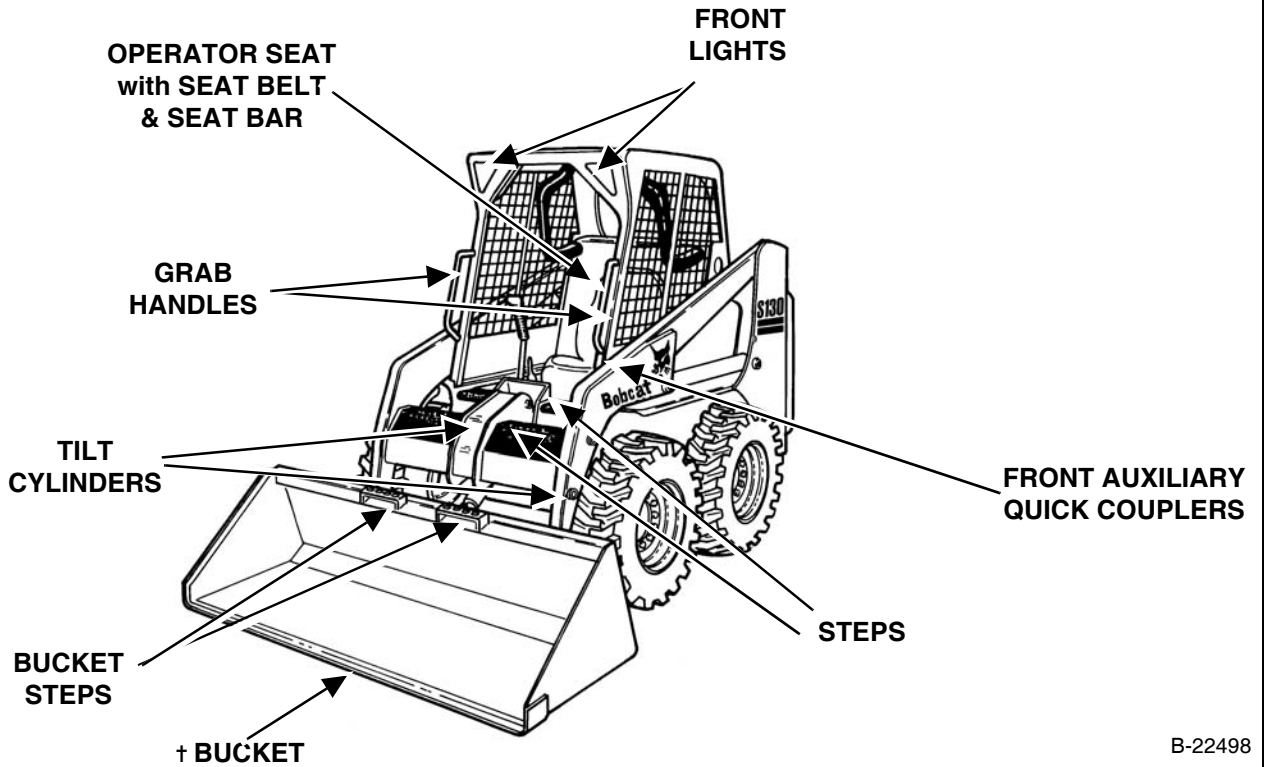

B-22498

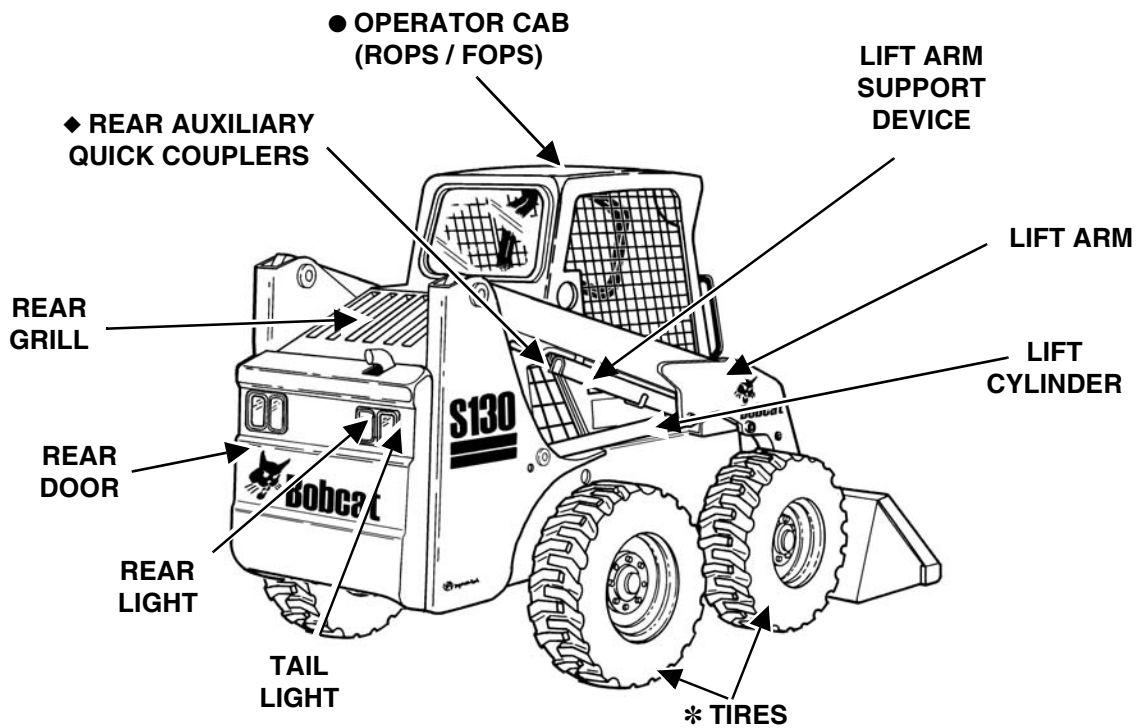

B-22499

◆ Optional or Field Accessory (Not Standard Equipment)

* TIRES - Tires shown may not be standard. The machine is factory equipped with standard tires. Other tires are available.

† Bucket - Several different buckets and other attachments are available for this machine.

● ROPS, FOPS - Roll Over Protective Structure, per SAE J1040 and ISO 3471, and Falling Object Protective Structure per ISO 3449, Level I. Level II is available.



Bobcat®

SAFETY AND MAINTENANCE

AIR CLEANER SERVICE 10-80-1
 Checking 10-80-1
 Replacing Filter Element(s) 10-80-2

BOB-TACH 10-150-1
 Inspection And Maintenance 10-150-1

ENGINE COOLING SYSTEM 10-90-1
 Cleaning The Cooling System 10-90-1
 Checking The Coolant Level 10-90-2
 Replacing The Coolant 10-90-3

ENGINE LUBRICATION SYSTEM 10-110-1
 Checking Engine Oil 10-110-1
 Engine Oil Chart 10-110-1
 Replacing Oil And Filter 10-110-1

FAN GEARBOX 10-140-1
 Checking And Maintaining 10-140-1

FINAL DRIVE TRANSMISSION (CHAINCASE) 10-130-1
 Checking And Adding Oil 10-130-1
 Removing The Oil 10-130-1

FUEL SYSTEM 10-100-1
 Filling the Fuel Tank 10-100-1
 Fuel Filter 10-100-2
 Fuel Specifications 10-100-1
 Removing Air From The Fuel System 10-100-3

HYDRAULIC/HYDROSTATIC SYSTEM 10-120-1
 Breather Cap 10-120-4
 Checking And Adding Fluid 10-120-1
 Hydraulic / Hydrostatic Fluid Chart 10-120-1
 Replacing Hydraulic Fluid 10-120-3
 Replacing Hydraulic/Hydrostatic Filter 10-120-2
 Replacing Hydrostatic Motor Case Drain Filter(s) 10-120-2

LIFT ARM SUPPORT DEVICE 10-20-1
 Installing Lift Arm Support Device 10-20-1
 Removing The Lift Arm Support Device 10-20-2

LIFTING AND BLOCKING THE LOADER 10-10-1
 Procedure 10-10-1

Continued On Next Page

SAFETY AND MAINTENANCE (CONT'D)

| | |
|--|----------|
| LUBRICATION OF THE BOBCAT LOADER | 10-160-1 |
| Procedure | 10-160-1 |
| OPERATOR CAB | 10-30-1 |
| Description | 10-30-1 |
| Emergency Exit | 10-30-3 |
| Lowering The Operator Cab | 10-30-2 |
| Raising The Operator Cab | 10-30-1 |
| POWER BOB-TACH | 10-151-1 |
| Inspection And Maintenance | 10-151-1 |
| REMOTE START | 10-60-1 |
| Procedure | 10-60-1 |
| SERVICE SCHEDULE | 10-70-1 |
| Chart | 10-70-1 |
| SPARK ARRESTOR MUFFLER | 10-180-1 |
| Servicing | 10-180-1 |
| TIRE MAINTENANCE | 10-170-1 |
| Mounting | 10-170-1 |
| Rotating | 10-170-1 |
| Wheel Nuts | 10-170-1 |
| TOWING THE LOADER | 10-50-1 |
| Procedure | 10-50-1 |
| TRANSPORTING THE BOBCAT LOADER | 10-40-1 |
| Procedure | 10-40-1 |

TIGHTEN ALL HARDWARE PER SIZE TO GRADE 5 TORQUE (See TORQUE SPECIFICATIONS FOR BOLTS on Page SPEC-30-1.) UNLESS OTHERWISE SPECIFIED.

LIFTING AND BLOCKING THE LOADER

Procedure

Figure 10-10-1

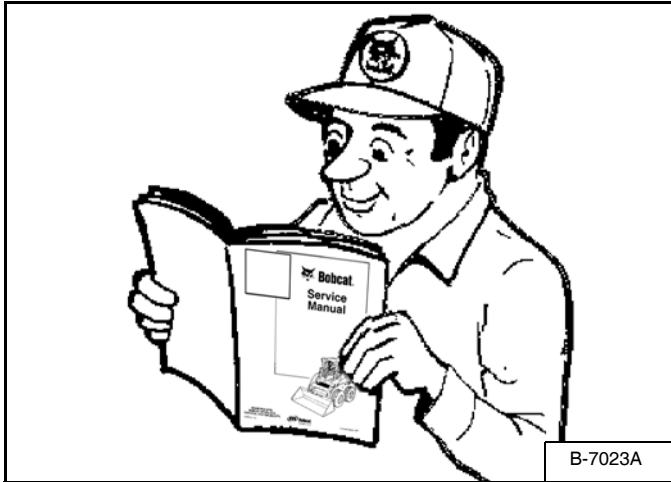

WARNING

Instructions are necessary before operating or servicing machine. Read and understand the Operation & Maintenance Manual, Handbook and signs (decals) on machine. Follow warnings and instructions in the manuals when making repairs, adjustments or servicing. Check for correct function after adjustments, repairs or service. Untrained operators and failure to follow instructions can cause injury or death.

W-2003-0199

Always park the loader on a level surface.

WARNING

Put jack stands under the front axles and rear corners of the frame before running the engine for service. Failure to use jack stands can allow the machine to fall or move and cause injury or death.

W-2017-0286

Figure 10-10-2



Put floor jack under the rear of the loader.

Lift the rear of the loader and install jack stands [Figure 10-10-2].

Figure 10-10-3

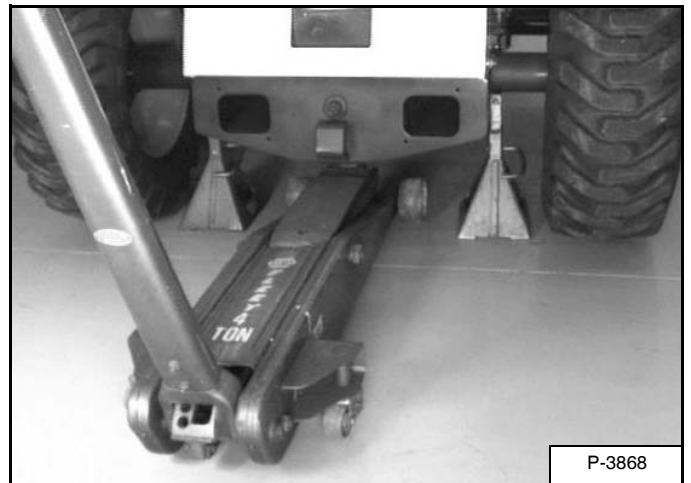

Put the floor jack under the front of the loader [Figure 10-10-3].

Lift the front of the loader and put jack stands under the axle tubes [Figure 10-10-3].

NOTE: Make sure the jack stands do not touch the tires. Make sure tires clear floor or any obstacles.



Bobcat®

LIFT ARM SUPPORT DEVICE

Installing Lift Arm Support Device

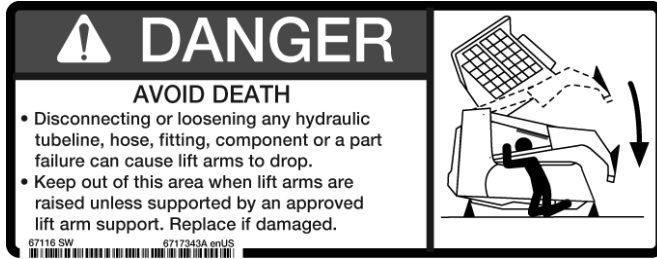

Never work on a machine with the lift arms up unless the lift arms are secured by an approved lift arm support device. Failure to use an approved lift arm support device can allow the lift arms or attachment to fall and cause injury or death.

W-2059-0598



Service lift arm support device if damaged or if parts are missing. Using a damaged lift arm support or with missing parts can cause lift arms to drop causing injury or death.

W-2271-1197

Figure 10-20-1

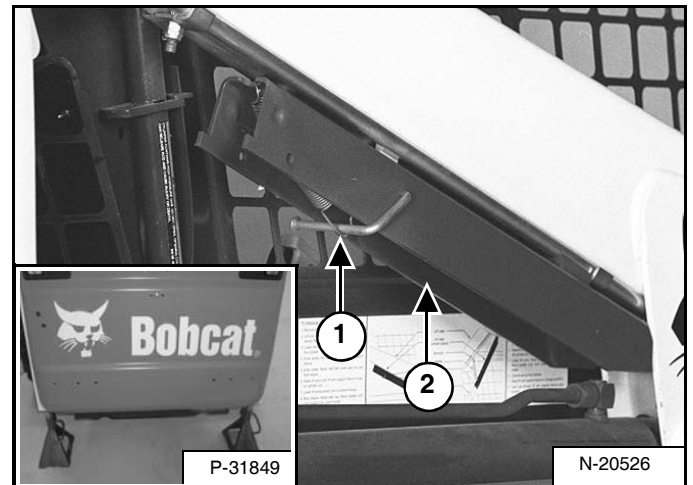

Put jack stands under the rear corners of the loader frame (Inset) [Figure 10-20-1].

Disconnect the spring from the lift arm support device retaining pin (Item 1). Support the lift arm support device (Item 2) [Figure 10-20-1] with your hand and remove the retaining pin.

Figure 10-20-2

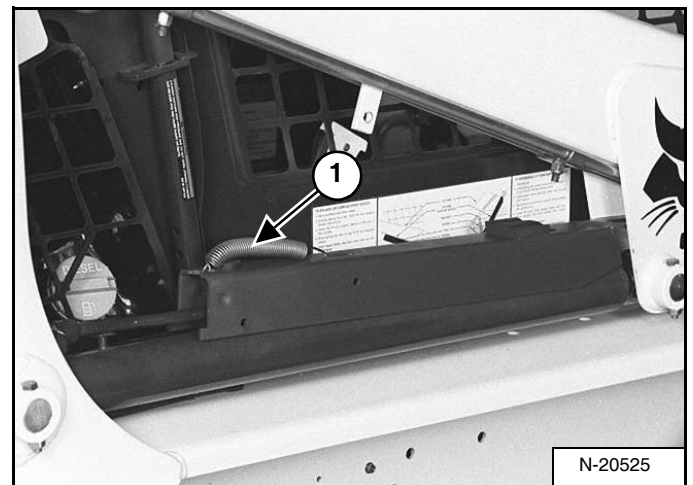

Lower the lift arm support device on top of the lift cylinder. Hook the free end of the spring (Item 1) [Figure 10-20-2] to the lift arm support device so there will be no interference with the support device engagement.

With the operator in the seat, seat belt fastened and seat bar lowered, start the engine.

LIFT ARM SUPPORT DEVICE (CONT'D)

Installing Lift Arm Support Device (Cont'd)

Figure 10-20-3

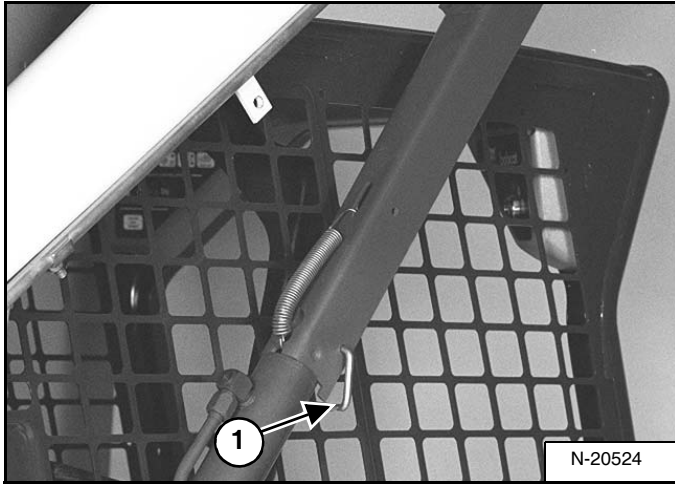

Raise the lift arms, until the lift arm support device drops onto the lift cylinder rod [Figure 10-20-3].

Lower the lift arms slowly until the support device is held between the lift arm and the lift cylinder. Stop the engine. Raise the seat bar and move pedals until both pedals lock.

Install pin (Item 1) [Figure 10-20-3] into the rear of the lift arm support device below the cylinder rod.

Removing The Lift Arm Support Device

Figure 10-20-4

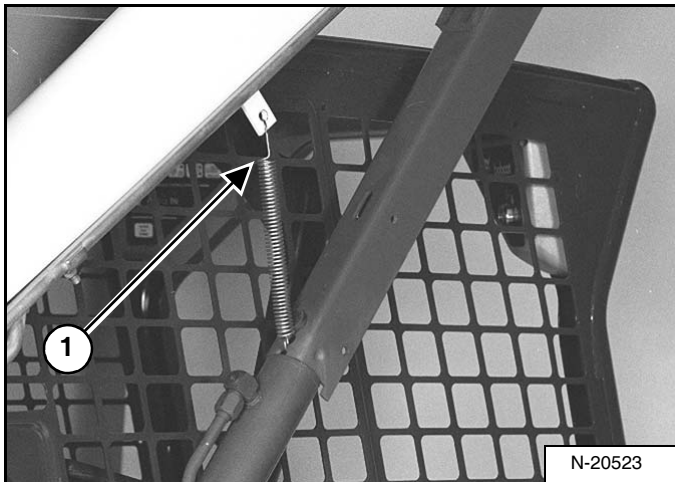

Remove the pin from the lift arm support device.

Connect the spring (Item 1) [Figure 10-20-4] from the lift arm support device to the bracket below the lift arms.

With the operator in the seat, seat belt fastened and seat bar lowered, start the engine.

Raise the lift arms a small amount and the spring will lift the support device off the lift cylinder rod. Lower the lift arms. Stop the engine.

Raise the seat bar and move pedals until both pedals lock.

Disconnect the spring from the bracket.

Figure 10-20-5

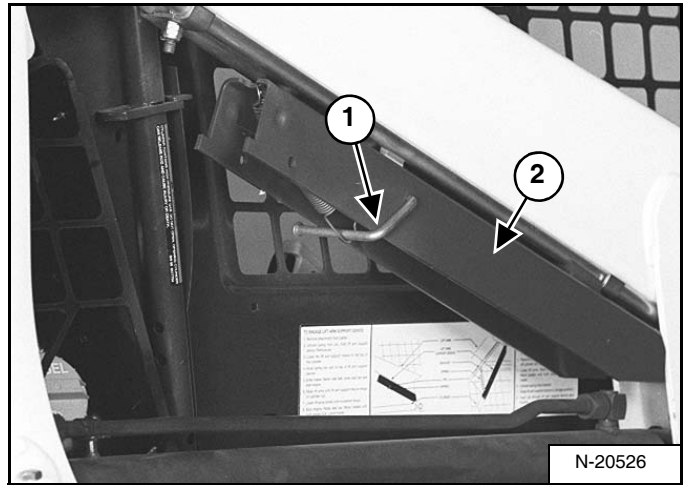

Raise the support device into storage position and insert pin (Item 1) through lift arm support device (Item 2) [Figure 10-20-5] and bracket. Connect spring to pin.

Remove jack stands.

OPERATOR CAB

Description

The Bobcat loader has an operator cab (ROPS and FOPS) as standard equipment to protect the operator from rollover and falling objects. Check with your dealer if the operator cab has been damaged. The seat belt must be worn for roll over protection.

ROPS/FOPS - Roll Over Protective Structure per SAE J1040 and ISO 3471, and Falling Object Protective Structure per SAE J1043 and ISO 3449, Level I. Level II is available.

Level I - Protection from falling bricks, small concrete blocks, and hand tools encountered in operations such as highway maintenance, landscaping, and other construction site services.

Level II - Protection from falling trees, rocks; for machines involved in site clearing, overhead demolition or forestry.

Raising The Operator Cab

Always stop the engine before raising or lowering the cab.

Stop the loader on a level surface. Lower the lift arms. If the lift arms must be up while raising the operator cab, install the lift arm support device. (See Installing Lift Arm Support Device on Page 10-20-1.)

Figure 10-30-1



Install jack stands under the rear of the loader frame [Figure 10-30-1].

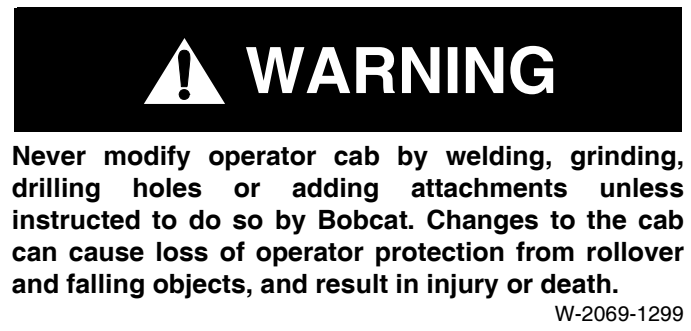

OPERATOR CAB (CONT'D)

Raising The Operator Cab (Cont'd)

Figure 10-30-2

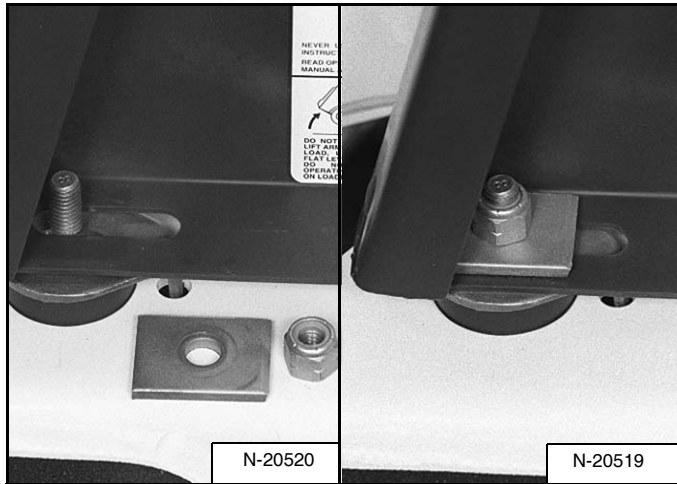

Loosen the nut (both sides) at the front corners of the operator cab [Figure 10-30-2].

Remove the nuts and plates [Figure 10-30-2] (both sides).

Figure 10-30-3



Lift on the grab handle and bottom of the operator cab slowly until the cab is all the way up and the latching mechanism engages [Figure 10-30-3].

Lowering The Operator Cab

Figure 10-30-4

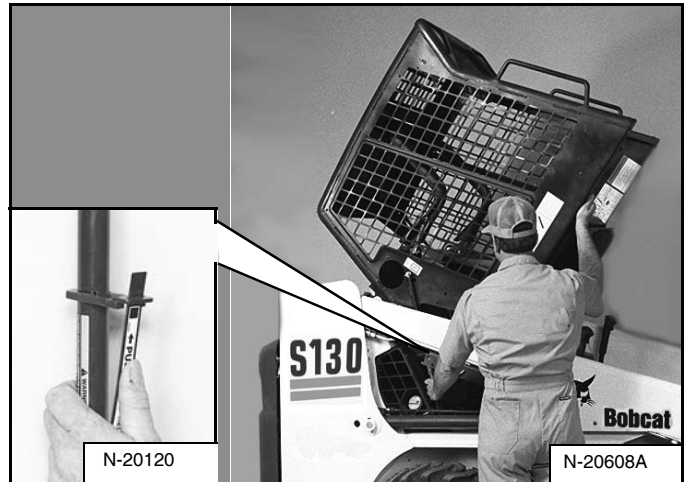

Always stop the engine before raising or lowering the cab.

NOTE: Make sure the seat bar is fully raised or lowered when lowering the cab. Always use the grab handles to lower the cab.

Pull down on the bottom of the operator cab until it stops at the latching mechanism [Figure 10-30-4].

Release the latching mechanism (Inset) [Figure 10-30-4] and pull the cab all the way down.

Figure 10-30-5

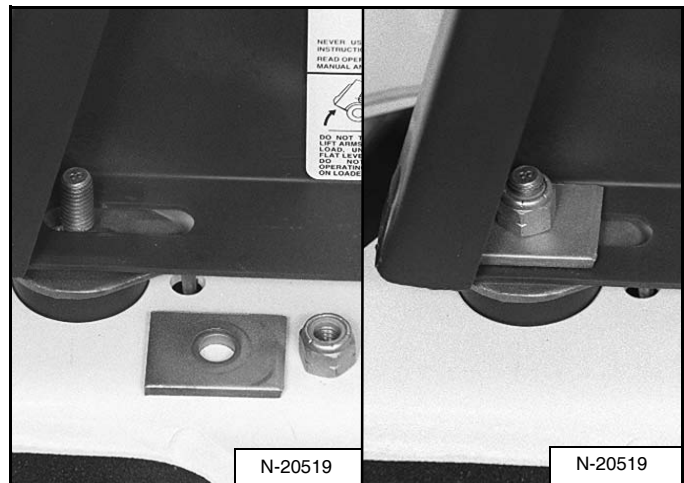

Install the plates and nuts [Figure 10-30-5] (both sides).

Tighten the nuts to 40-50 ft.-lb. (54-68 N•m) torque.

OPERATOR CAB (CONT'D)

Emergency Exit

Figure 10-30-6



The front opening on the operator cab and rear window provide exits.

Rear Window (If Equipped)

Pull on the tag on the top of the rear window to remove the rubber cord [Figure 10-30-6].

Figure 10-30-7



Push the rear window out of the rear of the operator cab.

Exit through the rear of the operator cab [Figure 10-30-7].

Figure 10-30-8

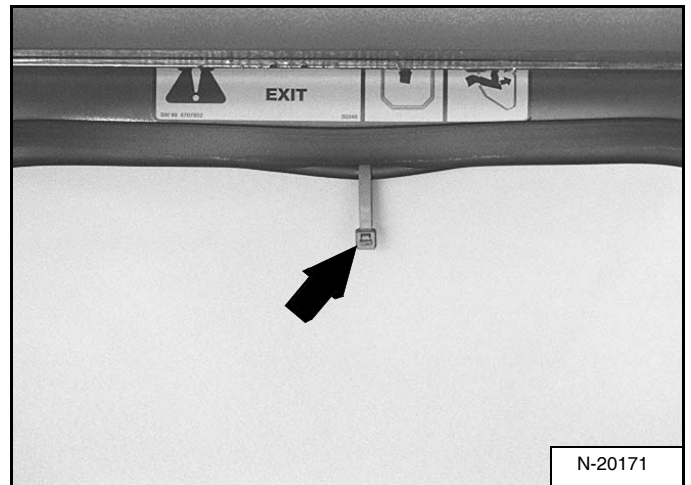

Front Door (If Equipped)

NOTE: When an Operator Cab Enclosure Kit is installed, the window of the front door can be used as an emergency exit. [Figure 10-30-8]

Pull the plastic loop at the top of the window in the front door to remove the rubber cord [Figure 10-30-8].

Figure 10-30-9

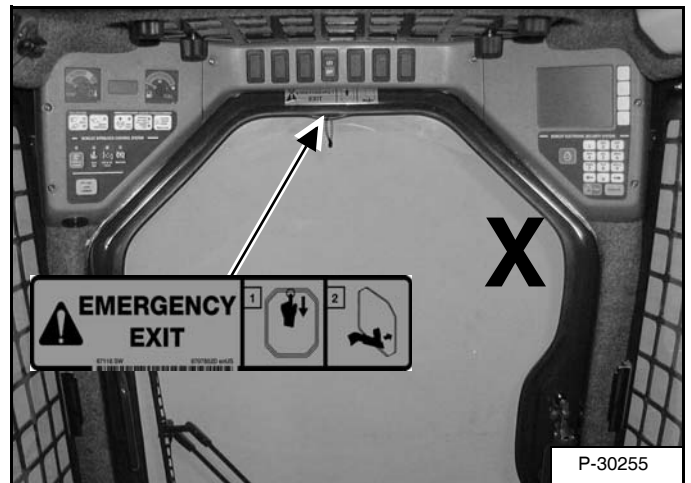

Push the window out with your foot [Figure 10-30-9] at any corner of the window.

Exit through the front door.



Bobcat®

TRANSPORTING THE BOBCAT LOADER

Procedure

WARNING

Adequately designed ramps of sufficient strength are needed to support the weight of the machine when loading onto a transport vehicle. Wood ramps can break and cause personal injury.

W-2058-0494

Figure 10-40-1



Be sure the transport and towing vehicles are of adequate size and capacity (See Performance on Page SPEC-10-2.)

A loader with an empty bucket or no attachment must be loaded backward onto the transport vehicle [Figure 10-40-1].

The rear of the trailer must be blocked or supported (Item 1) [Figure 10-40-1] when loading or unloading the loader to prevent the front end of the trailer from raising up.

Figure 10-40-2

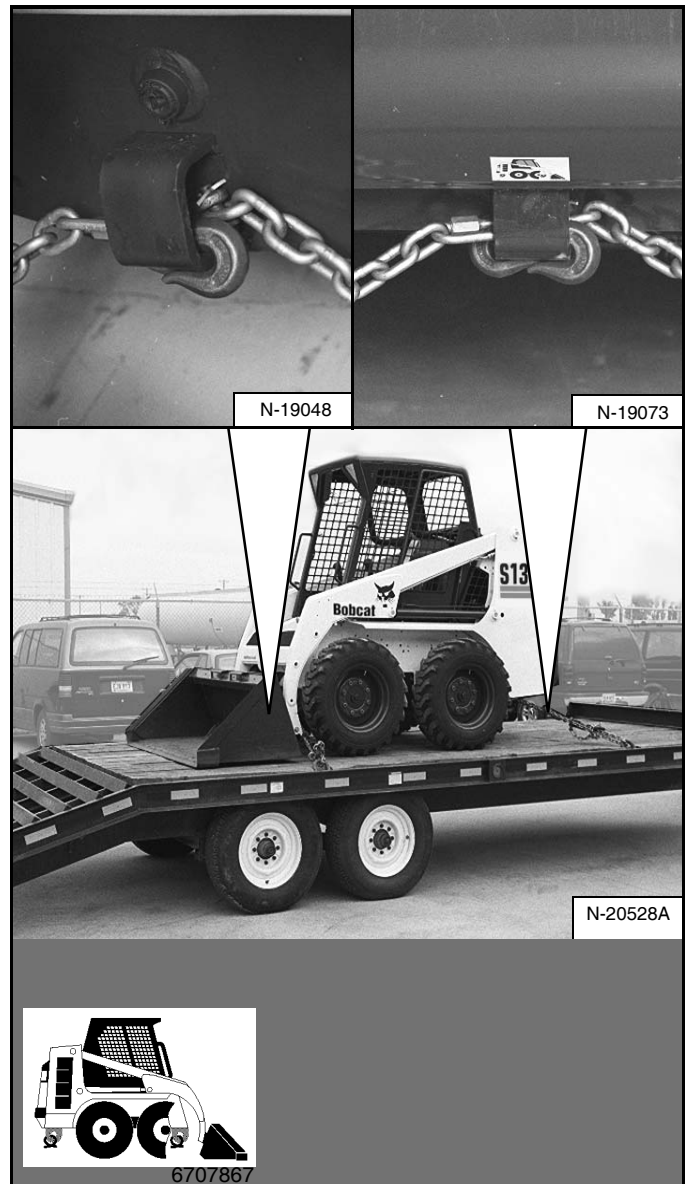

Use the following procedure to fasten the Bobcat loader to the transport vehicle to prevent the loader from moving during sudden stops or when going up or down slopes [Figure 10-40-2].

- Lower the bucket or attachment to the floor.
- Stop the engine.
- Engage the parking brake.
- Install chains at the front and rear loader tie down positions (Inset) [Figure 10-40-2].
- Fasten each end of the chain to the transport vehicle.

Product: Bobcat S130 Skid Steer Loader Service Repair Workshop Manual 524611001-524711001

Full Download: [https://www.arepairmanual.com/downloads/bobcat-s130-skid-ste](https://www.arepairmanual.com/downloads/bobcat-s130-skid-steer-loader-service-repair-workshop-manual-524611001-524711001)

[er-loader-service-repair-workshop-manual-524611001-524711001](https://www.arepairmanual.com/downloads/bobcat-s130-skid-steer-loader-service-repair-workshop-manual-524611001-524711001)

/



Bobcat®

Sample of manual. Download All 636 pages at:

<https://www.arepairmanual.com/downloads/bobcat-s130-skid-steer-loader-service-repair-workshop-manual-524611001-524711001>