

Product: Bobcat A300 Turbo Skid Steer Loader Service Repair Workshop Manual 526411001-526511001
Full Download: <https://www.aresairmanual.com/downloads/bobcat-a300-turbo-skid-steer-loader-service-repair-workshop-manual-526411001-526511001/>



Bobcat®

Service Manual

S/N 526411001 & Above
S/N 526511001 & Above

BOBCAT SKID-STEER LOADER
With ALL WHEEL STEER (AWS)

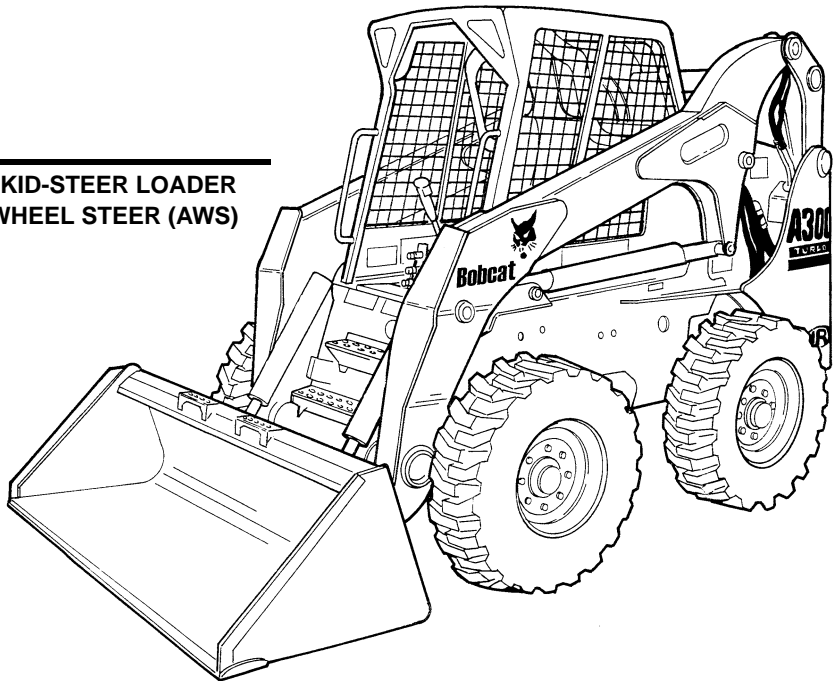

EQUIPPED WITH
BOBCAT INTERLOCK
CONTROLS SYSTEM (BICS)



Product: Bobcat A300 Turbo Skid Steer Loader Service Repair Workshop Manual 526411001-52651100
Full Download: <https://www.arepairmanual.com/downloads/bobcat-a300-turbo-skid-steer-loader-service-repair-workshop-manual-526411001-52651100/>

Sample of manual. Download All 802 pages at:
<https://www.arepairmanual.com/downloads/bobcat-a300-turbo-skid-steer-loader-service-repair-workshop-manual-526411001-52651100/>

MAINTENANCE SAFETY



WARNING

Instructions are necessary before operating or servicing machine. Read and understand the Operation & Maintenance Manual, Operator's Handbook and signs (decals) on machine. Follow warnings and instructions in the manuals when making repairs, adjustments or servicing. Check for correct function after adjustments, repairs or service. Untrained operators and failure to follow instructions can cause injury or death.

W-2003-0903



Safety Alert Symbol: This symbol with a warning statement, means: "Warning, be alert! Your safety is involved!" Carefully read the message that follows.

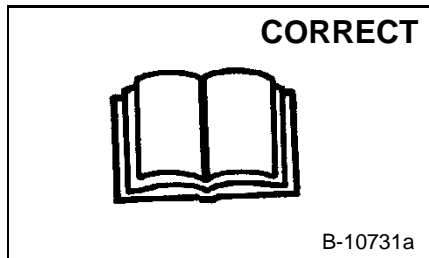

B-10731a

⚠ Never service the Bobcat Skid-Steer Loader without instructions.

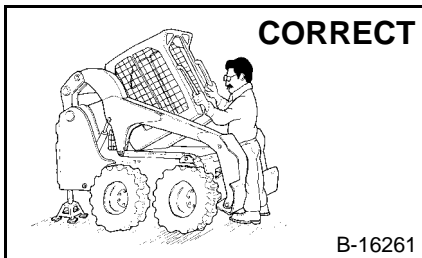

B-16261

⚠ Use the correct procedure to lift or lower operator cab.

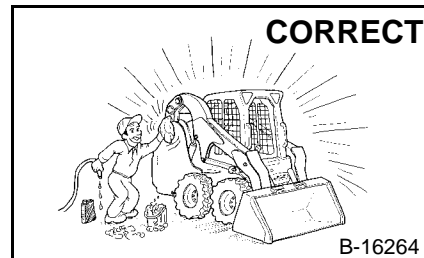

B-16264

⚠ Cleaning and maintenance are required daily.

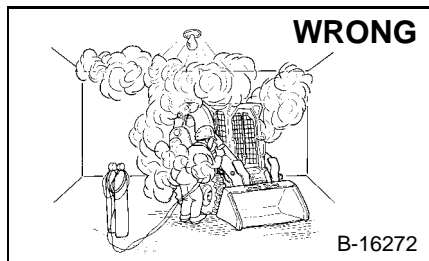

B-16272

- ⚠ Have good ventilation when welding or grinding painted parts.
- ⚠ Wear dust mask when grinding painted parts. Toxic dust and gas can be produced.
- ⚠ Avoid exhaust fume leaks which can kill without warning. Exhaust system must be tightly sealed.

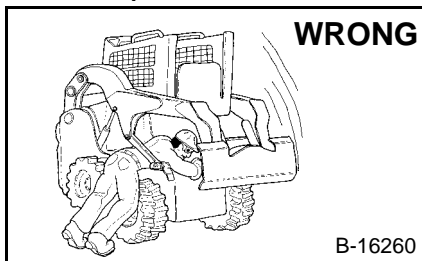

B-16260

⚠ Disconnecting or loosening any hydraulic tubeline, hose, fitting, component or a part failure can cause lift arms to drop. Do not go under lift arms when raised unless supported by an approved lift arm support device. Replace it if damaged.

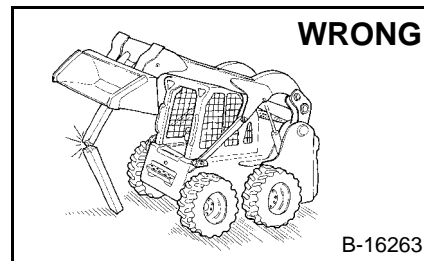

B-16263

- ⚠ Never work on loader with lift arms up unless lift arms are held by an approved lift arm support device. Replace if damaged.
- ⚠ Never modify equipment or add attachments not approved by Bobcat Company.

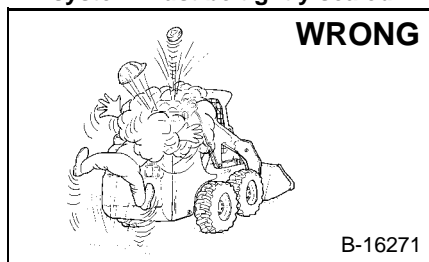

B-16271

- ⚠ Stop, cool and clean engine of flammable materials before checking fluids.
- ⚠ Never service or adjust loader with the engine running unless instructed to do so in the manual.
- ⚠ Avoid contact with leaking hydraulic fluid or diesel fuel under pressure. It can penetrate the skin or eyes.
- ⚠ Never fill fuel tank with engine running, while smoking or when near open flame.

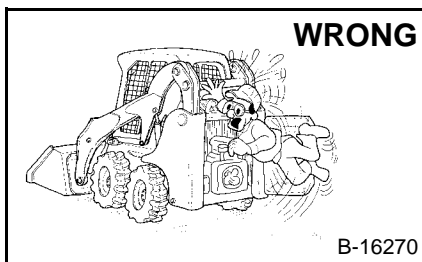

B-16270

- ⚠ Keep body, jewelry and clothing away from moving parts, electrical contact, hot parts and exhaust.
- ⚠ Wear eye protection to guard from battery acid, compressed springs, fluids under pressure and flying debris when engines are running or tools are used. Use eye protection approved for type of welding.
- ⚠ Keep rear door closed except for service. Close and latch door before operating the loader.



B-6589

- ⚠ Lead-acid batteries produce flammable and explosive gases.
- ⚠ Keep arcs, sparks, flames and lighted tobacco away from batteries.
- ⚠ Batteries contain acid which burns eyes or skin on contact. Wear protective clothing. If acid contacts body, flush well with water. For eye contact flush well and get immediate medical attention.

Maintenance procedures which are given in the Operation & Maintenance Manual can be performed by the owner/operator without any specific technical training. Maintenance procedures which are **not** in the Operation & Maintenance Manual must be performed **ONLY BY QUALIFIED BOBCAT SERVICE PERSONNEL**. Always use genuine Bobcat replacement parts. The Service Safety Training Course is available from your Bobcat dealer.

MSW14-0805



Bobcat®

ALPHABETICAL INDEX

AIR CLEANER	70-01	HEATER COIL	80-01
AIR CLEANER SERVICE	10-01	HEATER/AC FAN	80-01
AIR CONDITIONING SERVICE	80-01	HEATER VALVE	80-01
AIR CONDITIONING SYSTEM FLOW	80-01	HUB	40-01
ALTERNATOR	60-01	HYDRAULIC CONNECTION SPECS	SPEC-01
AUXILIARY PRESSURE RELEASE (ACCUMULATOR)	20-01	HYDRAULIC CONTROL VALVE (1 PIECE CASTING)	20-01
AWS CONTROLLER	60-01	HYDRAULIC CONTROL VALVE (2 PIECE CASTING)	20-01
 		HYDRAULIC FLUID RESERVOIR	20-01
BASIC TROUBLESHOOTING	80-01	HYDRAULIC/HYDROSTATIC FILTER	20-01
BATTERY	60-01	HYDRAULIC/HYDROSTATIC FLUID SPECIFICATIONS	SPEC-01
BOBCAT 2001 CONTROLLER	60-01	HYDRAULIC/HYDROSTATIC SYSTEM	10-01
BOB-TACH	10-01, 50-01	HYDRAULIC PUMP	20-01
BRAKE	40-01	HYDRAULIC PUMP (HI FLOW)	20-01
BRAKE (TWO-SPEED)	40-01	HYDRAULIC SYSTEM INFORMATION	20-01
BUCKET POSITION VALVE	20-01	HYDROSTATIC MOTOR	30-01
 		HYDROSTATIC PUMP	30-01
CALIBRATION	60-01	HYDROSTATIC SYSTEM INFORMATION	30-01
CHAINCASE	40-01	 	
CHARGE PRESSURE	30-01	INSIDE ACCESS PANEL	50-01
COOLING FAN	70-01	INSTRUMENT PANEL	60-01
COMPONENTS	80-01	 	
COMPRESSOR	80-01	LIFT ARMS	50-01
CONDENSER	80-01	LIFT ARM BY-PASS CONTROL VALVE	20-01
CONTROL PANEL	50-01	LIFT ARM SUPPORT DEVICE	10-01
CONTROL	50-01	LIFTING AND BLOCKING THE LOADER	10-01
CONVERSIONS	SPEC-01	LIGHTS	60-01
CYLINDER (LIFT)	20-01	LOADER SPECIFICATIONS	SPEC-01
CYLINDER (POWER BOB-TACH)	20-01	LOADER TORQUE	SPEC-01
CYLINDER (REAR)	20-01	LUBRICATING THE LOADER	10-01
CYLINDER (TILT)	20-01	 	
 		MAIN RELIEF VALVE	20-01
DIAGNOSTICS SERVICE CODES	60-01	MUFFLER	70-01
DRIVE BELT	30-01	 	
DRIVE COMPONENTS	40-01	OIL COOLER (SEAL TIGHT CONNECT) (STC)	30-01
 		OPERATOR CAB	10-01, 50-01
ELECTRICAL/HYDRAULIC CONTROLS		OPERATOR SEAT (STANDARD)	50-01
REFERENCE	60-01	OPERATOR SEAT (SUSPENSION)	50-01
ELECTRICAL SYSTEM INFORMATION	60-01	 	
ENGINE	70-01	POWER BOB-TACH (OPTION)	10-01, 50-01
ENGINE COMPONENTS AND TESTING	70-01	POWER BOB-TACH BLOCK	20-01
ENGINE COOLING SYSTEM	10-01	PRESSURE RELIEF VALVE	80-01
ENGINE LUBRICATION SYSTEM	10-01	PRESSURE SWITCH	80-01
ENGINE SPECIFICATIONS	SPEC-01	 	
ENGINE SPEED CONTROL	70-01	RADIATOR	70-01
EVAPORATOR	80-01	REAR AUXILIARY DIVERTER VALVE	20-01
EVAPORATOR/HEATER UNIT	80-01	REAR DOOR	50-01
EXPANSION VALVE	80-01	REAR GRILL	50-01
 		RECEIVER/DRIER	80-01
FAN GEARBOX	10-01	RECONDITIONING THE ENGINE	70-01
FINAL DRIVE TRANSMISSION (CHAINCASE) ..	10-01	REGULAR MAINTENANCE	80-01
FLYWHEEL AND HOUSING	70-01	REMOTE START	10-01
FUEL SYSTEM	10-01		
FUEL TANK	50-01		
GENERAL AIR CONDITIONING			
SERVICE GUIDELINES	80-01		

ALPHABETICAL INDEX (CONT'D)

SAFETY	80-01
SEAT BAR	50-01
SEAT BAR SENSOR	60-01
SELECT VALVE.....	20-01
SERVICE SCHEDULE	10-01
STARTER	60-01
STEERING BLOCK	40-01
STEERING SOLENOID.....	60-01
SYSTEM CHARGING AND RECLAMATION	80-01
SYSTEM TROUBLESHOOTING CHART	80-01
TEMPERATURE/PRESSURE	80-01
THERMOSTAT.....	80-01
TIRE MAINTENANCE	10-01
TORQUE SPECIFICATIONS FOR BOLTS	SPEC-01
TOWING THE LOADER	10-01
TRACTION LOCK.....	60-01
TRANSPORTING THE BOBCAT LOADER.....	10-01
TROUBLESHOOTING.....	70-01

CONTENTS

FOREWORD.....	II
SAFETY INSTRUCTIONS	V
SERIAL NUMBER LOCATION	IX
DELIVERY REPORT.....	X
BOBCAT LOADER IDENTIFICATION.....	XI
SAFETY AND MAINTENANCE.....	10-01
HYDRAULIC SYSTEM	20-01
HYDROSTATIC SYSTEM.....	30-01
DRIVE SYSTEM	40-01
MAIN FRAME	50-01
ELECTRICAL SYSTEM & ANALYSIS.....	60-01
ENGINE SERVICE	70-01
HEATING, VENTILATION, AIR CONDITIONING	80-01
SPECIFICATIONS.....	SPEC-01

**SAFETY &
MAINTENANCE**

**HYDRAULIC
SYSTEM**

**HYDROSTATIC
SYSTEM**

**DRIVE
SYSTEM**

MAIN FRAME

**ELECTRICAL
SYSTEM &
ANALYSIS**

**ENGINE
SERVICE**

HVAC

SPECIFICATIONS

FOREWORD

This manual is for the Bobcat loader mechanic. It provides necessary servicing and adjustment procedures for the Bobcat loader and its component parts and systems. Refer to the Operation & Maintenance Manual for operating instructions, starting procedure, daily checks, etc.

A general inspection of the following items must be made after the loader has had service or repair:

1. Check that the ROPS/FOPS (Including side screens) is in good condition and is not modified.

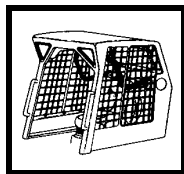

2. Check that ROPS mounting hardware is tightened and is Bobcat approved.

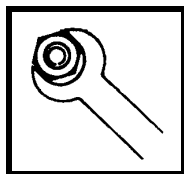

3. The seat belt must be correctly installed, functional and in good condition.

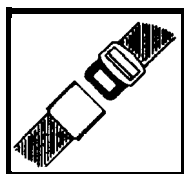

4. The seat bar must be correctly adjusted, clean and lubricated.

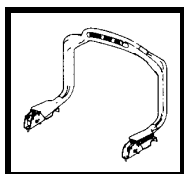

5. Check lift arm support device, replace if damaged.

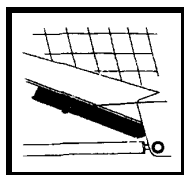

6. Machine signs must be legible and in the correct location.



7. Steering levers and foot pedals must return to neutral.

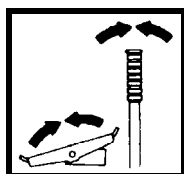

8. Check for correct function of the work lights



9. The parking brake must function correctly.

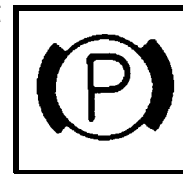

10. Enclosure door latches must open and close freely.

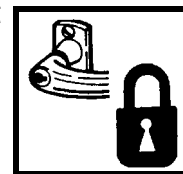

11. Bob-Tach wedges and linkages must function correctly and be in good condition.

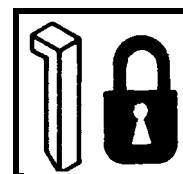

12. Safety treads must be in good condition.

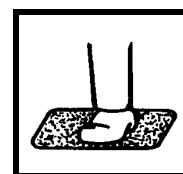

13. Check for correct function of indicator lamps (Optional on some models).

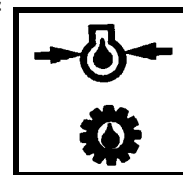

14. Check hydraulic fluid level, engine oil level and fuel supply.

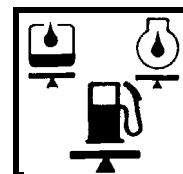

15. Inspect for fuel, oil or hydraulic fluid leaks.

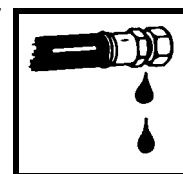

16. Lubricate the loader.

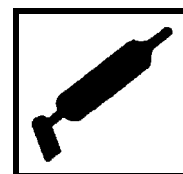

17. Check the condition of the battery and cables.

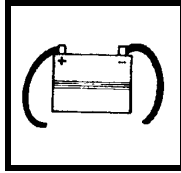

22. Operate the loader and check all functions.

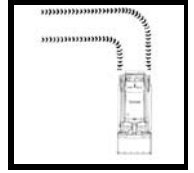

18. Inspect the air cleaner for damage or leaks. Check the condition of the element.

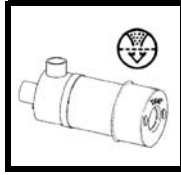

23. Check for any field modification not completed.



19. Check the electrical charging system.

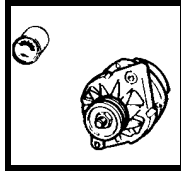

24. Check for correct function of the Bobcat Interlock Control System (BICST™) before the machine is returned to the customer.

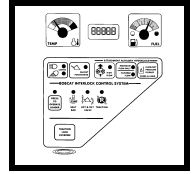

20. Check tires for wear and pressure.

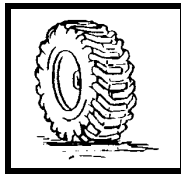

25. Recommend to the owner that all necessary corrections be made before the machine is returned to service.

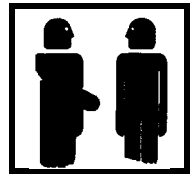

21. Inspect for loose or broken parts or connections.

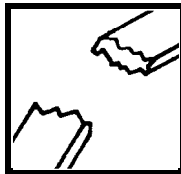

**CALIFORNIA
PROPOSITION 65 WARNING**
Diesel engine exhaust and some of its constituents are known to the State of California to cause cancer, birth defects and other reproductive harm.



Bobcat®

SAFETY INSTRUCTIONS



Safety Alert Symbol

This symbol with a warning statement means: "Warning, be alert! Your safety is involved!" Carefully read the message that follows.



WARNING

Instructions are necessary before operating or servicing machine. Read and understand the Operation & Maintenance Manual, Operator's Handbook and signs (decals) on machine. Follow warnings and instructions in the manuals when making repairs, adjustments or servicing. Check for correct function after adjustments, repairs or service. Untrained operators and failure to follow instructions can cause injury or death.

W-2003-0903



WARNING

Warnings on the machine and in the manuals are for your safety. Failure to obey warnings can cause injury or death.

W-2044-1285

IMPORTANT

This notice identifies procedures which must be followed to avoid damage to the machine.

I-2019-0284

The following publications provide information on the safe use and maintenance of the Bobcat machine and attachments:

- The Delivery Report is used to assure that complete instructions have been given to the new owner and that the machine is in safe operating condition.
- The Operation & Maintenance Manual delivered with the machine or attachment contains operating information as well as routine maintenance and service procedures. It is a part of the machine and can be stored in a container provided on the machine. Replacement Operation & Maintenance Manuals can be ordered from your Bobcat dealer.
- Machine signs (decals) instruct on the safe operation and care of your Bobcat machine or attachment. The signs and their locations are shown in the Operation & Maintenance Manual. Replacement signs are available from your Bobcat dealer.
- An Operator's Handbook fastened to the operator cab. It's brief instructions are convenient to the operator. The handbook is available from your dealer in an English edition or one of many other languages. See your Bobcat dealer for more information on translated versions.
- The AEM Safety Manual delivered with the machine gives general safety information.
- The Service Manual and Parts Manual are available from your dealer for use by mechanics to do shop-type service and repair work.
- The Skid-Steer Loader Operator Training Course is available through your local dealer or at www.training.bobcat.com or www.bobcat.com. This course is intended to provide rules and practices of correct operation of the Skid-Steer Loader. The course is available in English and Spanish versions.
- Service Safety Training Courses are available from your Bobcat dealer or at www.training.bobcat.com or www.bobcat.com. They provide information for safe and correct service procedures.
- The Skid-Steer Loader Safety Video is available from your Bobcat dealer or at www.training.bobcat.com or www.bobcat.com.

SI SSL-0206 SM

SAFETY INSTRUCTIONS (CONT'D)

The dealer and owner/operator review the recommended uses of the product when delivered. If the owner/operator will be using the machine for a different application(s) he or she must ask the dealer for recommendations on the new use.



Call Before You Dig

1-888-258-0808

When you call, you will be directed to a location in your state/city for information about buried lines (telephone, cable TV, water, sewer, gas, etc.)

SAFETY INSTRUCTIONS (CONT'D)

Fire Prevention

The machine and attachments have components that are at high temperature under normal operating conditions. The primary source of high temperatures is the engine and exhaust system. The electrical system, if damaged or incorrectly maintained, can be a source of arcs or sparks.

Flammable debris (leaves, straw, etc.) must be removed regularly. If flammable debris is allowed to accumulate, it will increase fire hazard. Clean often to avoid this accumulation. Flammable debris in the engine compartment is a potential hazard.

The spark arrestor muffler is designed to control the emission of hot particles from the engine and exhaust system, but the muffler and the exhaust gases are still hot.

- Do not use the machine where exhaust, arcs, sparks or hot components can contact flammable material, explosive dust or gases.
- The operator cab, engine compartment, and engine cooling system must be inspected every day and cleaned if necessary to prevent fire hazard and overheating.
- Check all electrical wiring and connections for damage. Keep the battery terminals clean and tight. Repair or replace any damaged part.
- Check fuel and hydraulic tubes, hoses and fittings for damage and leakage. Never use open flame or bare skin to check for leaks. Tighten or replace any parts that show leakage. Always clean fluid spills. Do not use gasoline or diesel fuel for cleaning parts. Use commercial nonflammable solvents.
- Do not use ether or starting fluids on any engine which has glow plugs. These starting aids can cause explosion and injure you or bystanders.
- Always clean the machine, disconnect the battery, and disconnect the wiring from the controllers before welding. Cover rubber hoses, battery and all other flammable parts. Keep a fire extinguisher near the machine when welding. Have good ventilation when grinding or welding painted parts. Wear a dust mask when grinding painted parts. Toxic dust or gas can be produced.
- Stop the engine and let it cool before adding fuel. **NO SMOKING!**

- Use the procedure in the Operation & Maintenance Manual for connecting the battery and for jump starting.
- Use the procedure in the Operation & Maintenance Manual for cleaning the spark arrestor muffler (if equipped).

Figure 1

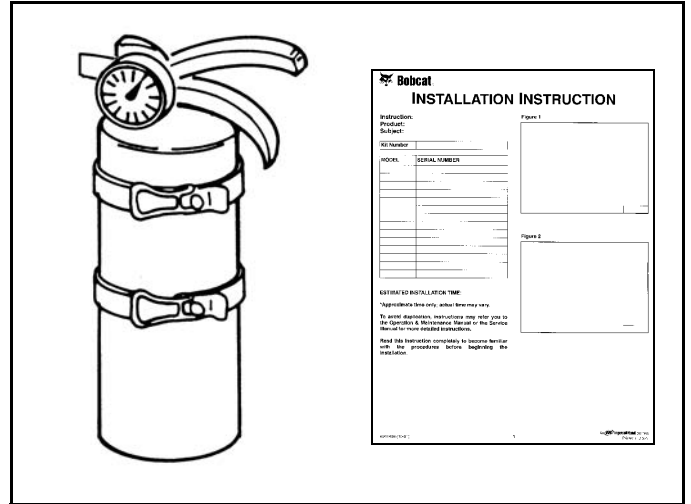

- Know where fire extinguishers and first aid kits are located and how to use them. Fire extinguishers are available from your Bobcat dealer [Figure 1].



Bobcat®

SERIAL NUMBER LOCATION

Always use the serial number of the loader when requesting service information or when ordering parts. Early or later models (identification made by serial number) may use different parts, or it may be necessary to use a different procedure in doing a specific service operation.

Loader Serial Number

Figure 2

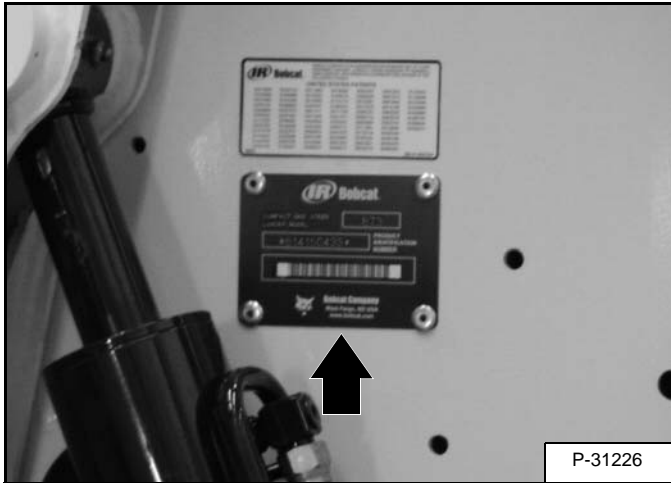

The loader serial number plate is located on the outside of the loader frame [Figure 2].

Explanation of loader Serial Number:

XXXX	XXXXX
Model 1.-Model/ Engine Combination	Model 2.-Production Sequence (Series)

1. The four digit Model/Engine Combination Module number identifies the model number and engine combination.
2. The five digit Production Sequence Number identifies the order which the loader is produced.

Engine Serial Number

Figure 3

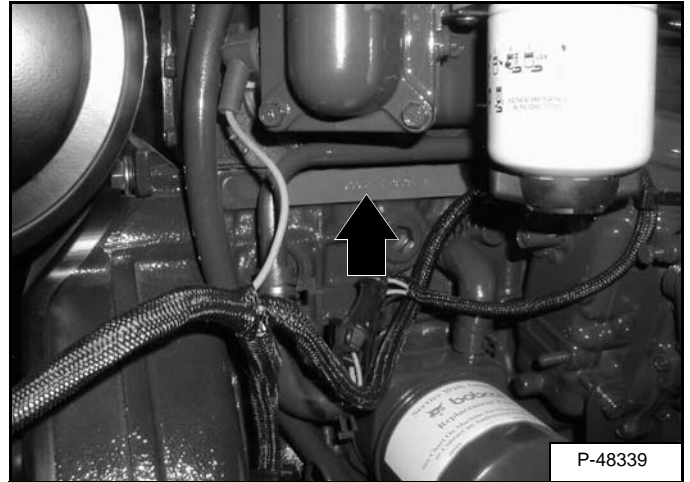

The engine serial number is located on the engine block [Figure 3].

DELIVERY REPORT

Figure 4

The diagram shows a form layout for a delivery report. It includes a title 'DELIVERY REPORT', a 'WARNING' section, and various text entry areas represented by horizontal lines. A reference code 'B-16315' is located in the bottom right corner of the form's frame.

The Delivery Report must be filled out by the dealer and signed by the owner or operator when the Bobcat loader is delivered. An explanation of the form must be given to the owner. Make sure it is filled out completely **[Figure 4]**.

BOBCAT LOADER IDENTIFICATION

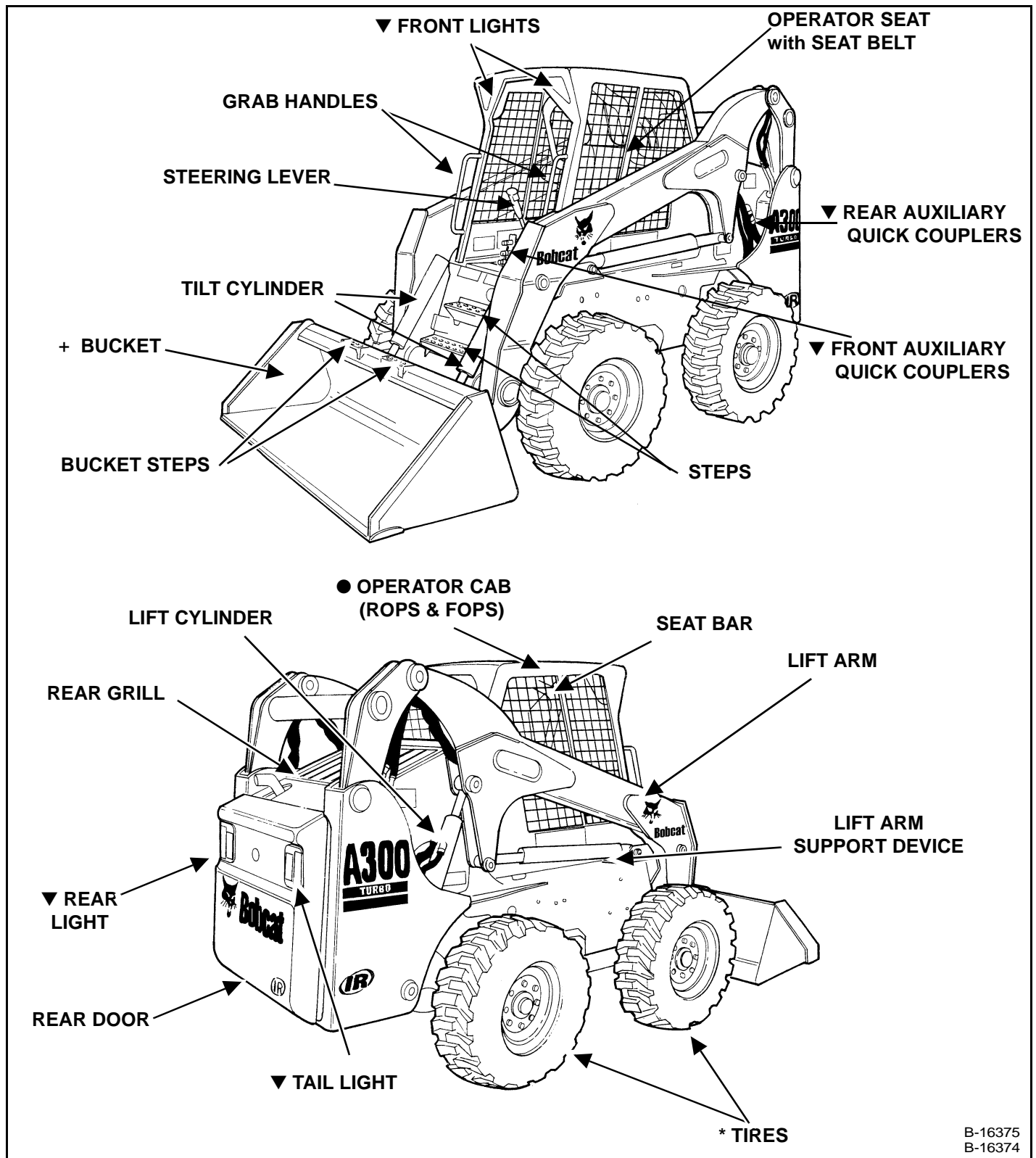

B-16375
B-16374

▼ OPTIONAL OR FIELD ACCESSORY (Not Standard Equipment)

* TIRES - Flotation tires are shown. The Bobcat loader is factory equipped with standard tires.

+ BUCKET - Several different buckets and other attachments are available for the Bobcat loader.

● ROPS, FOPS - Roll Over Protective Structure, per SAE J1040 and ISO 3471, and Falling Object Protective Structure per SAEJ1043 and ISO 3449, Level I. Level II is available. The Bobcat loader is base-equipped with a standard operator cab as shown. Extra insulated cab is available as an option (Reduced noise level).



Bobcat®

SAFETY AND MAINTENANCE

AIR CLEANER SERVICE 10-80-1
 Replacing Filter Element 10-80-1

BOB-TACH 10-150-1
 Inspection And Maintenance 10-150-1

ENGINE COOLING SYSTEM 10-90-1
 Adding The Coolant 10-90-4
 Checking The Coolant Level 10-90-3
 Cleaning Cooling System 10-90-1

ENGINE LUBRICATION SYSTEM 10-110-1
 Checking Engine Oil 10-110-1
 Oil Chart 10-110-1
 Replacing Oil And Filter 10-110-1

FAN GEARBOX 10-140-1
 Checking And Adding Oil 10-140-1

FINAL DRIVE TRANSMISSION (CHAINCASE) 10-130-1
 Checking And Adding Oil 10-130-1
 Removing The Oil 10-130-1

FUEL SYSTEM 10-100-1
 Filling The Fuel Tank 10-100-1
 Fuel Filter 10-100-2
 Fuel Specifications 10-100-1
 Removing Air From The Fuel System 10-100-2

HYDRAULIC/HYDROSTATIC SYSTEM 10-120-1
 Checking And Adding Fluid 10-120-1
 Hydraulic/Hydrostatic Filter Replacement 10-120-2
 Hydraulic Fluid Chart 10-120-1
 Replacing Hydraulic Fluid And Case Drain Filters 10-120-3

LIFT ARM SUPPORT DEVICE 10-20-1
 Installing The Lift Arm Support Device 10-20-1
 Removing The Lift Arm Support Device 10-20-2

LIFTING AND BLOCKING THE LOADER 10-10-1
 Procedure 10-10-1

LUBRICATING THE LOADER 10-160-1
 Procedure 10-160-1

Continued On Next Page

SAFETY AND MAINTENANCE (CONT'D)

OPERATOR CAB	10-30-1
Description	10-30-1
Emergency Exit	10-30-2
Lowering The Operator Cab	10-30-2
Raising The Operator Cab	10-30-1
POWER BOB-TACH	10-151-1
Inspection And Maintenance	10-151-1
REMOTE START	10-60-1
Procedure	10-60-3
Procedure For Loader With Attachments Control Harness	10-60-2
Procedure For Loader W/O Attachments Control Harness	10-60-1
SERVICE SCHEDULE	10-70-1
Chart	10-70-1
TIRE MAINTENANCE	10-170-1
Tire Mounting	10-170-1
Tire Rotation	10-170-1
Wheel Nuts	10-170-1
TOWING THE LOADER	10-50-1
Procedure	10-50-1
TRANSPORTING THE BOBCAT LOADER	10-40-1
Procedure	10-40-1

LIFTING AND BLOCKING THE LOADER

Procedure

Figure 10-10-1

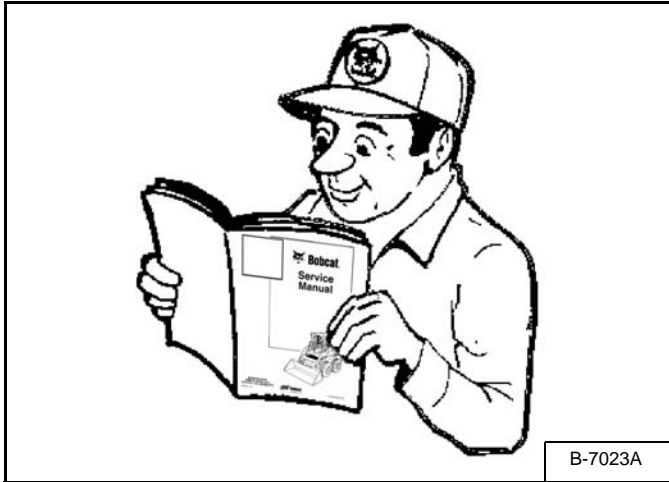

Instructions are necessary before operating or servicing machine. Read and understand the Operation & Maintenance Manual, Operator's Handbook and signs (decals) on machine. Follow warnings and instructions in the manuals when making repairs, adjustments or servicing. Check for correct function after adjustments, repairs or service. Untrained operators and failure to follow instructions can cause injury or death.

W-2003-0903

Read the Removal & Installation, Disassembly & Assembly, etc. completely to become familiar with the procedure before beginning [Figure 10-10-1].

Always park the loader on a level surface.



Put jackstands under the front axles and rear corners of the frame before running the engine for service. Failure to use jackstands can allow the machine to fall or move and cause injury or death.

W-2017-0286

Figure 10-10-2



Lift the rear of the loader and install jackstands [Figure 10-10-2].

Figure 10-10-3



Lift the front of the loader and put jackstands under the axle tubes [Figure 10-10-3].

NOTE: Make sure the jackstands do not touch the tires.



Bobcat®

LIFT ARM SUPPORT DEVICE

Installing The Lift Arm Support Device

Figure 10-20-1

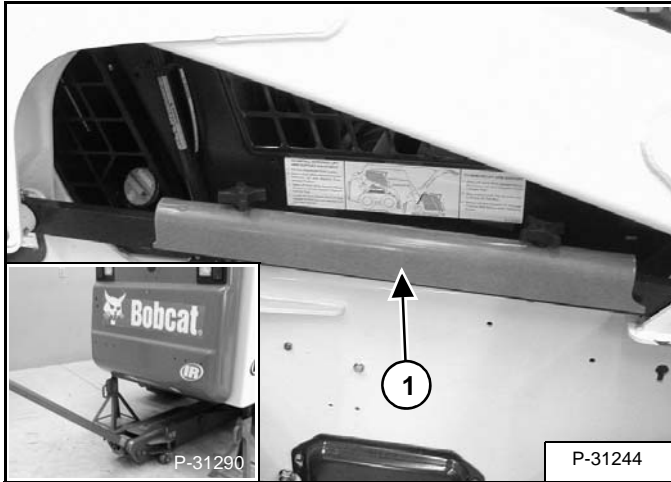

Never work on a machine with the lift arms up unless the lift arms are secured by an approved lift arm support device. Failure to use an approved lift arm support device can allow the lift arms or attachment to fall and cause injury or death.

W-2059-0598



Service lift arm support device if damaged or if parts are missing. Using a damaged lift arm support or with missing parts can cause lift arms to drop causing injury or death.

W-2271-1197

<p>AVOID DEATH</p> <ul style="list-style-type: none">• Disconnecting or loosening any hydraulic tubeline, hose, fitting, component or a part failure can cause lift arms to drop.• Keep out of this area when lift arms are raised unless supported by an approved lift arm support. Replace if damaged. <p>67118 SW 6712343A enUS 1001 2001 2002 2003 2004 2005 2006 2007 2008 2009 2010 2011 2012 2013 2014 2015 2016 2017 2018 2019 2020</p>	

Put jackstands under the rear corners of the loader frame (Inset) [Figure 10-20-1].

Remove the lift arm support device (Item 1) [Figure 10-20-1] from the storage position.

The operator must stay in the operator seat with the seat belt fastened and the seat bar lowered, until the lift arm support device is installed.

Start the engine and raise the lift arms all the way up.

Figure 10-20-2



Have a second person install the lift arm support device over the rod of one of the lift cylinders [Figure 10-20-2].

The lift arm support device must be tight against the cylinder rod. The tabs of the lift arm support device must be under the cylinder as shown (Inset) [Figure 10-20-2].

LIFT ARM SUPPORT DEVICE (CONT'D)

Installing The Lift Arm Support Device (Cont'd)

Figure 10-20-3



Lower the lift arms slowly until the lift arm support device is held between the lift arms and lift cylinder **[Figure 10-20-3]**.

Removing The Lift Arm Support Device

The operator must be in the operator's seat, with the seat belt fastened and seat bar lowered, until the lift arm support device is removed and the lift arms are lowered all the way.

Start the engine, raise the lift arms all the way up.

Have a second person remove the lift arm support device.

Lower the lift arms all the way and stop the engine.

Return the lift arm support device to storage position and secure with clamping knobs.

Remove the jackstands.

OPERATOR CAB

Description

The Bobcat loader has an operator cab (ROPS and FOPS) as standard equipment to protect the operator from rollover and falling objects. Check with your dealer if the operator cab has been damaged. The seat belt must be worn for roll over protection.

ROPS/FOPS - Roll Over Protective Structure per SAE J1040 and ISO 3471, and Falling Object Protective Structure per SAE J1043 and ISO 3449, Level I. Level II is available.

Level I - Protection from falling bricks, small concrete blocks, and hand tools encountered in operations such as highway maintenance, landscaping, and other construction site services.

Level II - Protection from falling trees, rocks; for machines involved in site clearing, overhead demolition or forestry.

Raising The Operator Cab

Figure 10-30-1

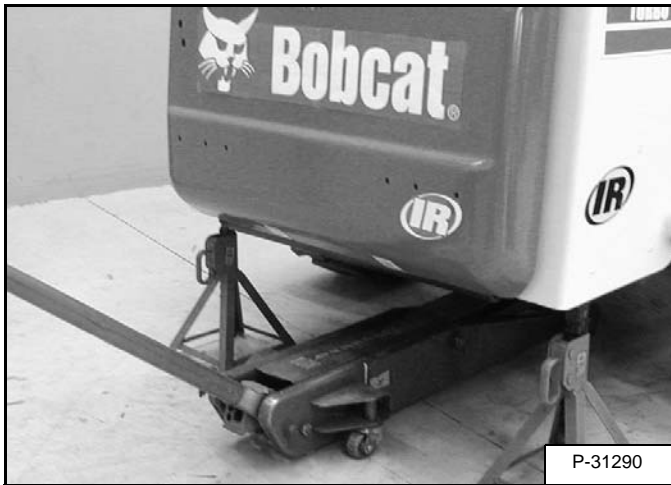

Always stop the engine before raising or lowering the cab.

Stop the loader on a level surface. Lower the lift arms. If the lift arms must be up while raising the operator cab, install the lift arm support device. (See Installing The Lift Arm Support Device on Page 10-20-1.)

Install jackstands under the rear of the loader frame [Figure 10-30-1].

Figure 10-30-2

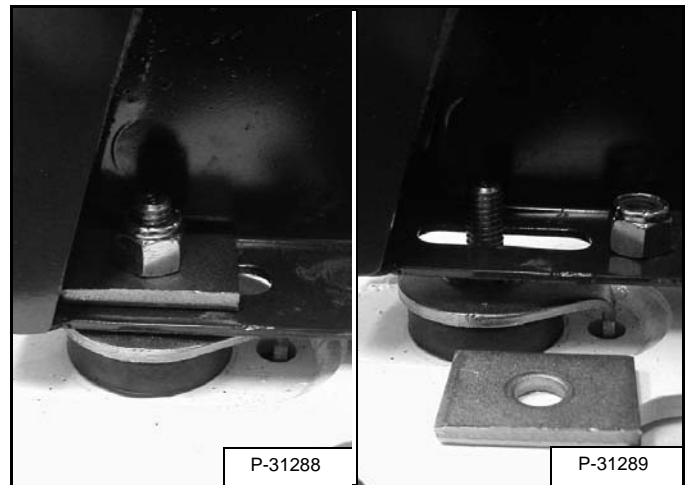

Loosen the nut (both sides) at the front corner of the operator cab [Figure 10-30-2].

Remove the nuts and plates [Figure 10-30-2] (both sides).

Figure 10-30-3



Lift on the grab handle and bottom of the operator cab slowly until the cab is all the way up and the latching mechanism engages [Figure 10-30-3].

OPERATOR CAB (CONT'D)

Raising The Operator Cab (Cont'd)

Advanced Hand Control Only



Never modify operator cab by welding, grinding, drilling holes or adding attachments unless instructed to do so by Bobcat. Changes to the cab can cause loss of operator protection from rollover and falling objects, and result in injury or death.

W-2069-1299

Lowering The Operator Cab

Figure 10-30-4

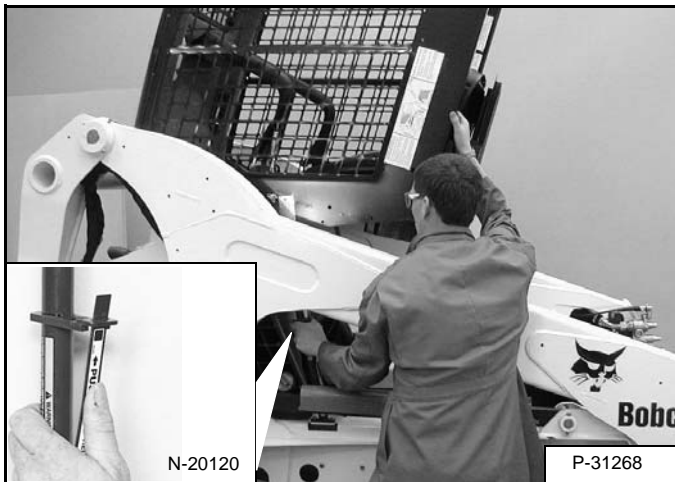

Always stop the engine before raising or lowering the cab.

NOTE: Make sure the seat bar is fully raised or lowered when lowering the cab. Always use the grab handles to lower the cab.

Pull down on the bottom of the operator cab until it stops at the latching mechanism [Figure 10-30-4].

Release the latching mechanism (Inset) [Figure 10-30-4] and pull the cab all the way down.

Figure 10-30-5

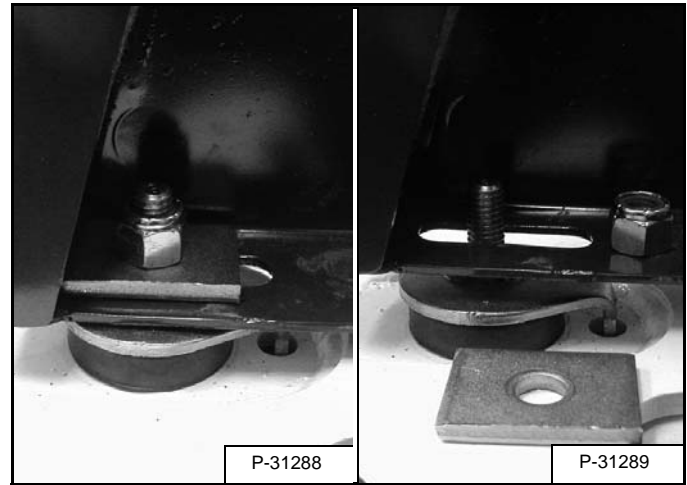

Install the plates and nuts [Figure 10-30-5] (both sides).

Tighten the nuts to 40-50 ft.-lb. (54-68 N•m) torque.

Emergency Exit

Figure 10-30-6



The front opening on the operator cab and rear window provide exits.

REAR WINDOW (If Equipped)

Pull on the tag on the top of the rear window to remove the rubber cord [Figure 10-30-6].

OPERATOR CAB (CONT'D)

Emergency Exit (Cont'd)

Figure 10-30-7



Push the rear window out of the rear of the operator cab.

Exit through the rear of the operator cab [Figure 10-30-7].

Figure 10-30-8

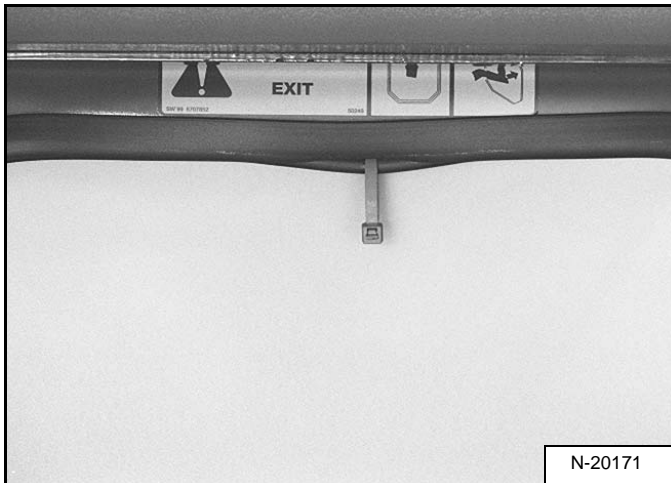

FRONT DOOR (If Equipped)

NOTE: When an Operator Cab Enclosure Kit is installed, the window of the front door can be used as an emergency exit [Figure 10-30-8].

NOTE: When the special applications kit is installed, the front door cannot be used for an emergency exit.

Pull the plastic loop at the top of the window in the front door to remove the rubber cord [Figure 10-30-8].

Figure 10-30-9

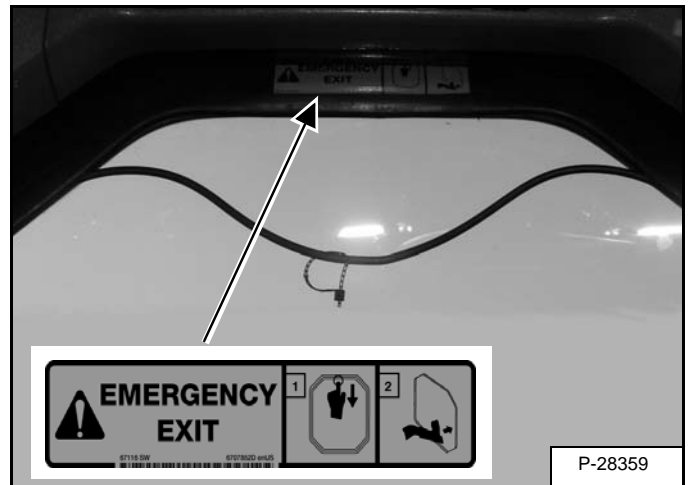

Push the window out with your foot [Figure 10-30-9] at any corner of the window.

Exit through the front door.



Bobcat®

TRANSPORTING THE BOBCAT LOADER

Procedure

Figure 10-40-1



Adequately designed ramps of sufficient strength are needed to support the weight of the machine when loading onto a transport vehicle. Wood ramps can break and cause personal injury.

W-2058-0494

A loader with an empty bucket or no attachment must be loaded backward onto the transport vehicle [Figure 10-40-1].

Be sure the transport and towing vehicles are of adequate size and capacity (See LOADER SPECIFICATIONS (A300) on Page SPEC-10-1.)

The rear of the trailer must be blocked or supported (Item 1) [Figure 10-40-1] when loading or unloading the loader to prevent the front end of the trailer from raising up.

Figure 10-40-2

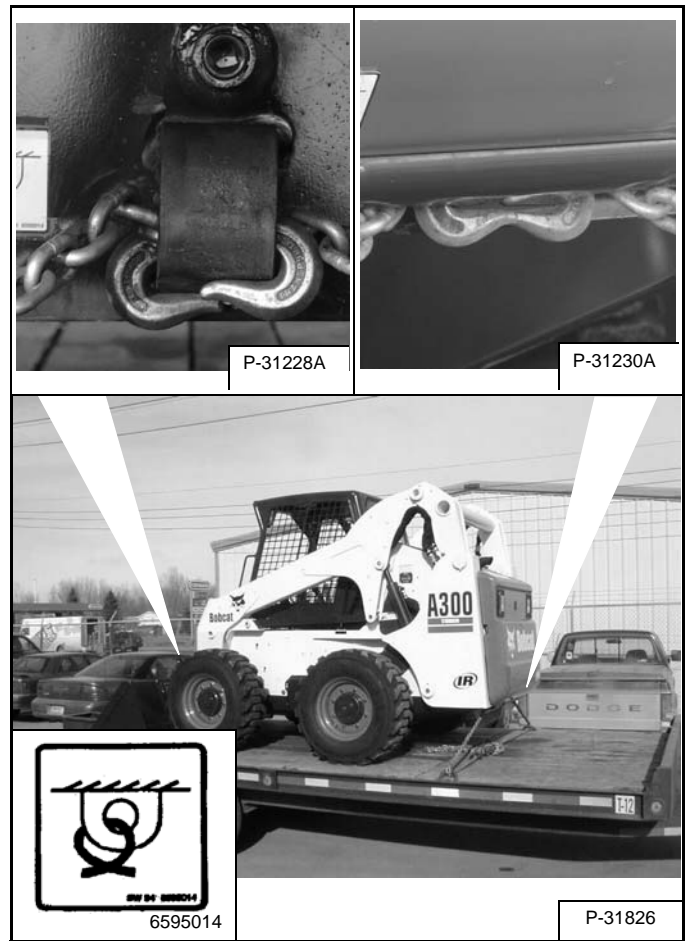

Use the following procedure to fasten the Bobcat loader to the transport vehicle to prevent the loader from moving during sudden stops or when going up or down slopes [Figure 10-40-2].

- Lower the bucket or attachment to the floor.
- Stop the engine.
- Engage the parking brake.
- Install chains at the front and rear loader tie down positions (Inset) [Figure 10-40-2].
- Fasten each end of the chain to the transport vehicle.

Product: Bobcat A300 Turbo Skid Steer Loader Service Repair Workshop Manual 526411001-52651100
Full Download: <https://www.arepairmanual.com/downloads/bobcat-a300-turbo-skid-steer-loader-service-repair-workshop-manual-526411001-52651100/>



Sample of manual. Download All 802 pages at:

<https://www.arepairmanual.com/downloads/bobcat-a300-turbo-skid-steer-loader-service-repair-workshop-manual-526411001-52651100/>